



Owner's Manual with Installation Instructions

Banks Techni-Cooler[®] Intercooler System

1999-2006 4.0L I-6 Jeep Wrangler

THIS MANUAL IS FOR USE WITH SYSTEMS: 1999-2004 WRANGLER - SYSTEM 25400, 2005-2006 WRANGLER - SYSTEM 25402

Gale Banks Engineering
546 Duggan Avenue • Azusa, CA 91702
(626) 969-9600 • Fax (626) 334-1743

Product Information & Sales: (888) 635-4565
Customer Support: (888) 839-5600
Installation Support: (888) 839-2700

bankspower.com



Additional products available from Banks for the 1999-2006 Jeep Wrangler



Banks iQ® System (P/N 61195)

- 5" touchscreen Man-Machine Interface
- Interchangeable gauge display, read and clear codes, monitor engine diagnostics, log data, time your vehicles runs and much more.

Banks Straight-Shot® Water-Methanol Injection (P/N 45001)

- Maximizes Engine Performance
- Cools Intake Temperatures
- Digital Controller (included)
- Plug-and-Play wiring
- Greater flow than the competition
- Higher Pump Volume than others.

Banks Double-Shot® Water-Methanol Injection (P/N 45003)

- The Double-Shot system offers the same benefits of the Straight-Shot and adds a second stage for increased output and control.

Banks Ram-Air® Filter (P/N 41506X)

- Large Conical lifetime
- High-flow filtration

Banks Ram-Air® Pre-Filter (P/N 42640)

- Extra layer of filtration protection

Banks Blow-Off Valve Spacer (P/N 24285)

- Reduces intake air temperatures
- Quickens turbo response
- Unmistakable sound

Banks TorqueTubes® Exhaust Manifold, 4.0L (P/N 51306)

- Improves power and torque.
- Reduces engine load.
- Improves economy.
- Tough construction.

Banks Monster® Exhaust System (P/N 51314, 51315)

- Increases exhaust flow.
- Decreases backpressure.
- Lowers exhaust gas temperatures.
- Increases power.

Banks Monster® Muffler Delete (P/N 51306)

- Minimizes backpressure for increased turbocharger response, adds aggressive exhaust tone.

**For More Information please call (888) 635-4565
or Visit us online @ www.bankspower.com**

Dear Customer,

If you have any questions concerning the installation of your Banks Sidewinder® Turbo System, please call our Technical Service Hotline at (888) 839-2700 between 7:00 am and 4:00 pm (PT). If you have any questions relating to shipping or billing, please contact our Customer Service Department at (888) 839-5600.

Thank you.

Table of Contents

General Installation Practices.....	3
Tools Required	3
Banks Techni-Cooler® Intercooler System Installation Procedure	
Low Temperature Radiator install	4
Pump and Wiring install	6
Techni-Cooler Install	7
Plumbing install.....	8
Parts List	10

General Installation Practices

1. For ease of installation of your Banks Techni-Cooler® Intercooler System, familiarize yourself with the procedure by reading the entire manual before starting work. This instruction manual contains 11 pages of text, illustrations and parts listing.

2. Route and tie wires and hoses a minimum of 6" away from exhaust heat, moving parts and sharp edges. Clearance of 8" or more is recommended where possible.

3. When raising the vehicle, support it on properly weight-rated safety stands, ramps or a commercial hoist. Follow the manufacturer's safety precautions. Take care to balance the vehicle to prevent it from slipping or falling. When using ramps, be sure the front wheels are centered squarely on the topsides; put the transmission in park; set the hand brake; and place blocks behind the rear wheels.

⚠ CAUTION: *Do not use floor jacks to support the vehicle while working under it. Do not raise the vehicle onto concrete blocks, masonry or any other item not intended specifically for this use.*

4. During installation, keep your work area and components clean to avoid possible dirt entry into the engine.

5. For proper performance and to prevent engine damage it is essential that your engine systems be capable of supporting the additional requirements of the Banks Sidewinder® Turbo System. To ensure proper performance, please complete every step in the engine health inspection section.

Tools Required

- 1/8" and 3/8" drive ratchets with inch and metric sockets
- 1/4" and 3/8" drive extensions
- Inch and metric combination or open-end wrenches
- Standard and Phillips head screwdrivers
- Standard & needle nose pliers
- Clean shop towels or rags.....
- Inch-pound or foot-pound torque wrench.....
- Compressed air source and hoses
- Flashlight or shop light
- Ear and eye protection
- Drill and stepped drill bit
- Permanent marker.....
- Coolant Drain Pan
- 1 1/2" Hole Saw.....

Highly recommended Tools and Supplies:

- Penetrating oil or light lubricant spray.....
- Deburring tool

NOTICE: ***Banks Power Techni-Cooler system was developed and tested using vehicles with OEM radiator and air conditioning condenser. Engine cooling performance and fitment cannot be guaranteed if you are using an aftermarket radiator or A/C condenser.***

Techni-Cooler® Intercooler System Installation Procedure

Figure 1

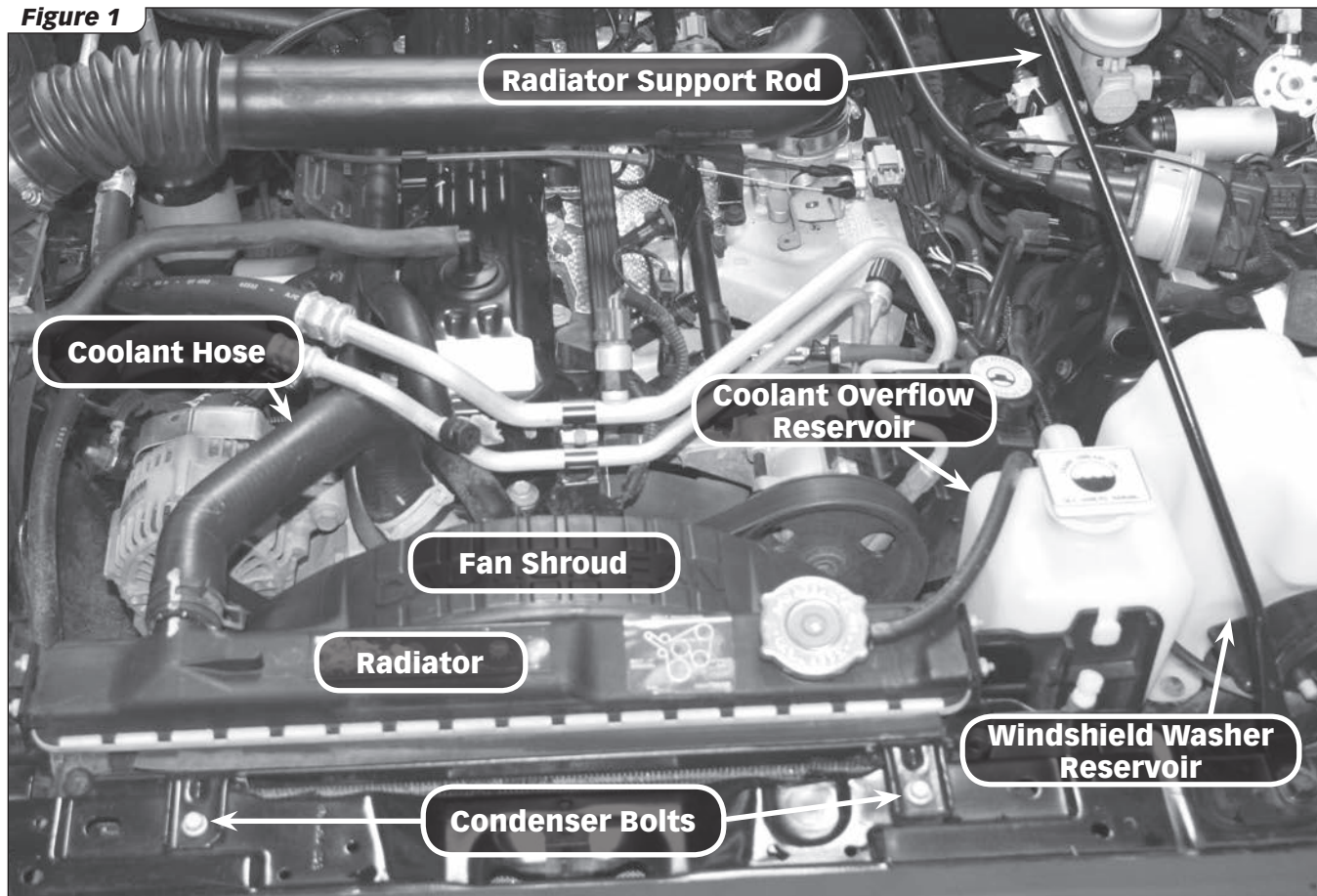

LOW TEMPERATURE RADIATOR INSTALL

⚠ CAUTION: *Disconnect battery or batteries before beginning this installation.*

1. Remove both radiator support rods for better access. **See Figure 1**

 15 mm socket

2. Drain coolant system using the petcock on the bottom passenger side of the radiator.

3. Remove coolant overflow reservoir by lifting to release catches and pulling towards rear of vehicle. **See Figure 1**

4. Remove radiator fan and shroud. Remove radiator by removing 4 bolts and disconnecting 2 coolant hoses. Cover open ports and store in clean area to keep it free of debris. **See Figure 1**

 11 mm socket (Shroud)
 10 mm socket (Radiator)

5. Remove 4 air conditioning condenser bolts and use tie wraps to hold condenser clear of radiator support to allow installation of Banks low temperature radiator (LTR) (P/N 25411). **See Figures 1 & 2**

 10 mm socket

NOTICE: *It is NOT necessary to disconnect air conditioning lines, move as far as lines will allow.*

6. Remove front radiator brace by removing 2 upper bolts and 1 lower bolt.

 10 mm socket

7. Remove windshield washer fluid reservoir mounting bolts for better access to drill holes for intercooler hoses. **See Figure 1**

 10 mm socket

NOTICE: *It is NOT necessary to disconnect windshield washer fluid hoses, move as far as hoses will allow.*

8. Carefully drill one 1.5" hole in the corner on each side of the front clip approximately 13.75" from center for intercooler hose pass-throughs. **See Figures 3 & 4**

⚠ CAUTION: *Use extreme caution when drilling holes, take care to avoid wiring and headlight bezel.*

9. Completely deburr holes to avoid damaging the intercooler hoses and place grommets (P/N 93655) into holes to cover exposed sheet metal. **See Figure 5**

Figure 2

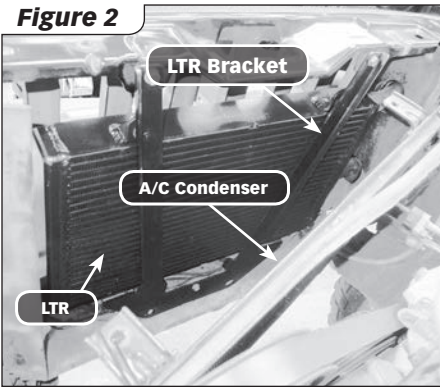

Figure 4

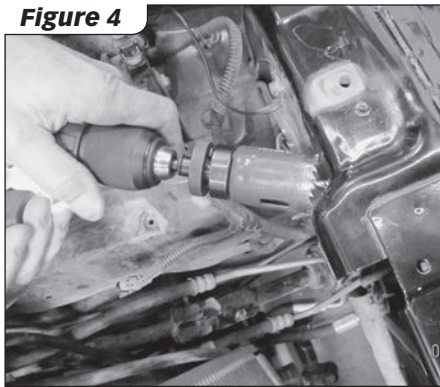

Figure 6

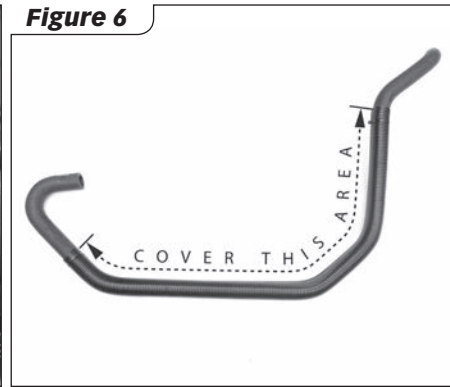

Figure 3



Figure 7

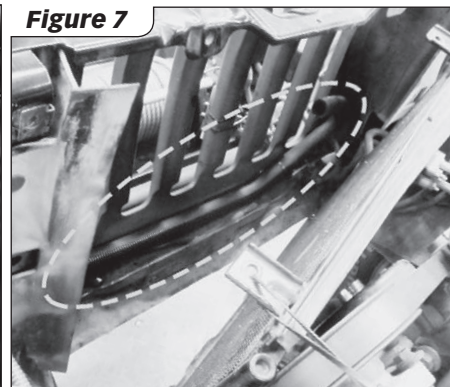
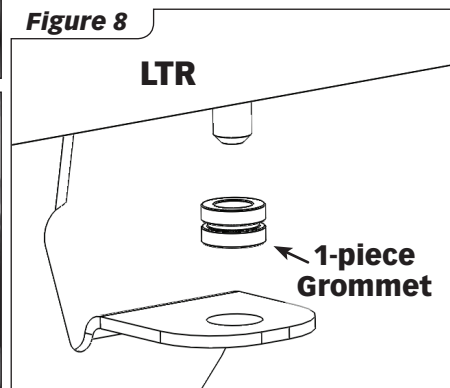

Figure 8



10. Replace windshield washer fluid reservoir.

11. Cover LTR outlet hose (P/N 94268-05) with corrugated loom (P/N W-CCL-100), as shown. **See Figure 6**

12. Place LTR outlet hose with corrugated loom into bottom of radiator support and pass through driver side grommet, as shown. Trim air deflectors as necessary. **See Figure 7**

13. Mount LTR to the LTR mounting bracket (P/N 25412) using grommets (P/N 25413) in the lower mounting holes and bushing isolators (P/N 25414) on the upper studs. Use fender washers (P/N 91180) and Nyloc nuts (P/N 91161) to secure LTR to mounting bracket. **See Figures 8 & 9**

See Figures 8 & 9

 7/16" socket

14. Mount LTR and LTR bracket where the front radiator brace was located. **See Figure 2**

Figure 5



Figure 9

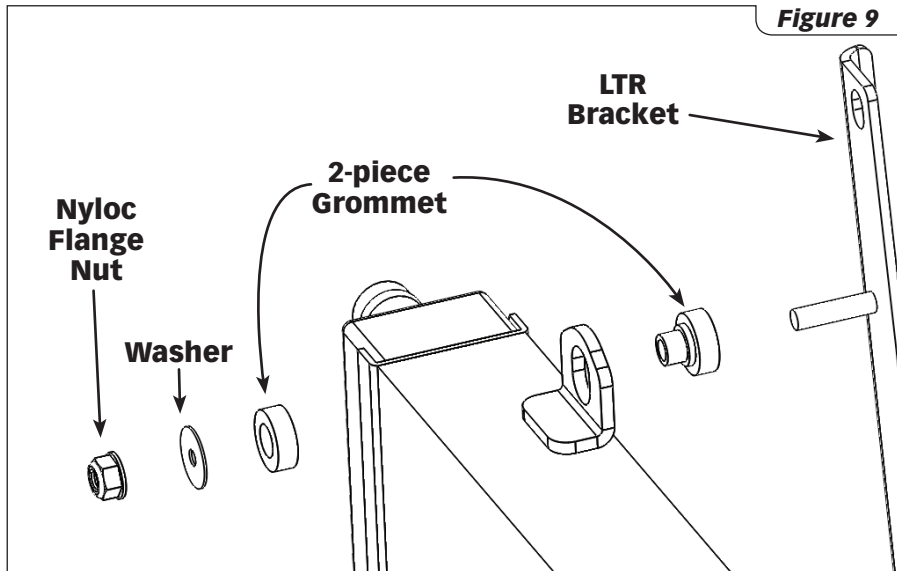

15. If necessary, modify ambient temperature sensor by trimming catch and rotating the top away from the LTR, as shown. **See Figure 10**

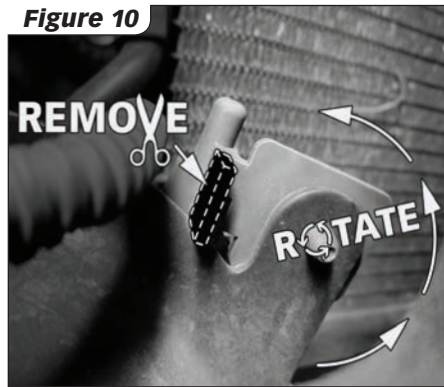

Figure 10

16. Connect the LTR outlet hose to the lower barb of the LTR and secure using hose clamp (P/N 92810). Trim air deflectors as necessary. **See Figure 11**

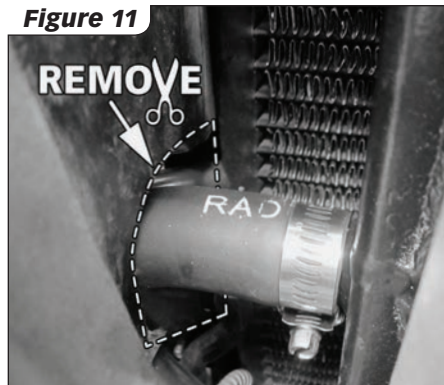

Figure 11



Figure 14

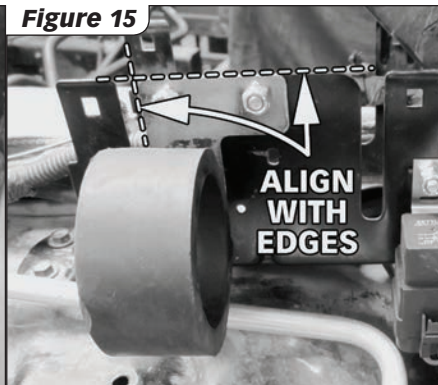

Figure 15

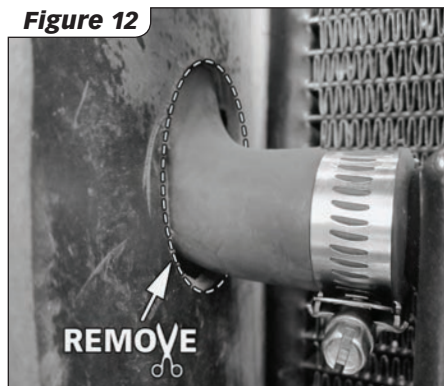

Figure 12

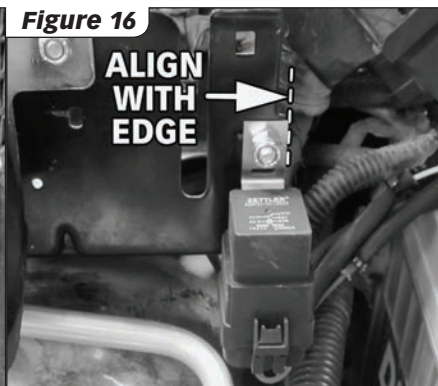

Figure 16

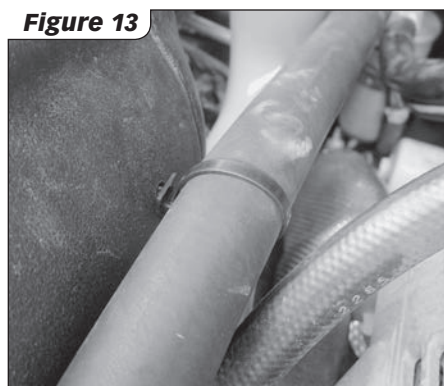

Figure 13

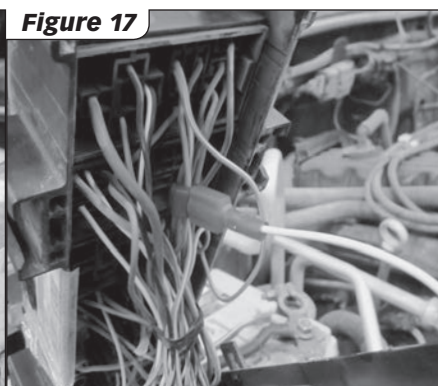

Figure 17

17. Pass LTR inlet hose (P/N 94267) through passenger side grommet and connect to upper barb of the LTR. Secure using hose clamp (P/N 92810). Trim air deflectors as necessary. **See Figure 12**

18. Drill a 1/4" hole into airbox to hold LTR inlet hose away from engine components. Secure LTR inlet hose using push mount cable tie (P/N 62006). **See Figure 13.**

19. Reinstall air conditioning condenser using provided replacement well nuts (P/N 91164).

20. Reinstall radiator using original hardware and reconnect hoses. Reinstall coolant overflow reservoir. Fill radiator with appropriate automotive coolant to factory specs.

PUMP AND WIRING INSTALL

1. Release 4 tabs on the fuse box to free entire fuse box for access to wires on the bottom side. Leave all wires connected, if possible. **See Figure 14.**

2. Drill intercooler pump mounting bracket (P/N 25418) holes (.25") and wire harness relay mounting holes (.25") on fuse box sheet metal as shown in **Figure 15 & 16.**

3. Locate the fuel pump relay and tap the hot side of signal lead (orange/red wire) using supplied wire T-tap (P/N 62032). **See Figure 17.**

4. Connect male faston connector (yellow lead) of the intercooler pump wire harness (P/N 62802) to the wire T-tap. Route with other wires towards the battery.

5. Mount the relay using 1/4"-20 bolt (P/N 91171) and Nyloc flange nut (P/N 91161). **See Figure 16.**

6. Mount the intercooler pump brackets (P/N 25418) using 1/4"-20 bolts (P/N 91171) and Nyloc flange nuts (P/N 91161). **See Figure 18.**

7. Replace fuse box onto sheet metal mount and check that all 4 tabs engage.

8. Mount intercooler pump (P/N 25419) in pump bracket with pump head towards rear of vehicle and outlet barb horizontal towards engine as shown. Connect the pump power connector to the pump and connect the pump outlet hose. Secure using hose clamp (P/N 92810). **See Figure 18.**

TECHNI-COOLER INSTALL

1. Remove underhood light from bracket by lifting edge. Remove mounting bracket. **See Figure 19.**

 10 mm socket

2. Drill a 3/16" hole approximately 2-3/8" to the left of the original hole to relocate the light. Replace bracket and light as shown in **Figure 19.**

3. Remove lower two bulkhead connectors from the firewall (upper connector for automatic transmission does not need to be relocated) and install bulkhead connector relocation bracket (P/N 25408) using 2 bolts (P/N 91115) and Nyloc flange nut (P/N 91161). **See Figure 20.**

4. If adding Techni-Cooler kit to a previously installed Sidewinder turbo kit, remove the existing boost tube and disconnect the wastegate reference line.

5. Remove appropriate valve cover bolts to allow for Techni-Cooler installation (P/N 25404), as shown. **See Figure 21.**

6. Replace valve cover bolts with provided studs (P/N 91193) and flange nuts (P/N 91160). Install studs with Threadlocker (P/N 90001) leaving 3/4" threads above the valve cover, as shown. **See Figure 22 & 23.**

7. Install Techni-Cooler brackets (P/N 25405-05, 25405-07) onto studs using washers (P/N 91102) below the bracket and Nyloc flange nuts (P/N 91161) to secure it, as shown. **See Figure 24**

 7/16" socket

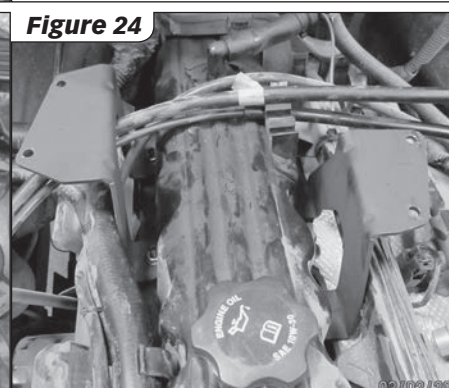
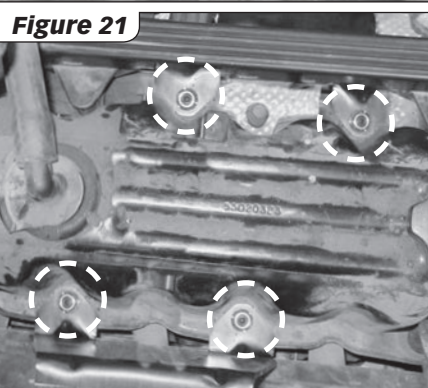
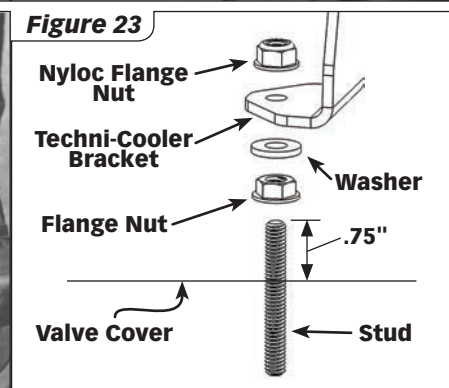
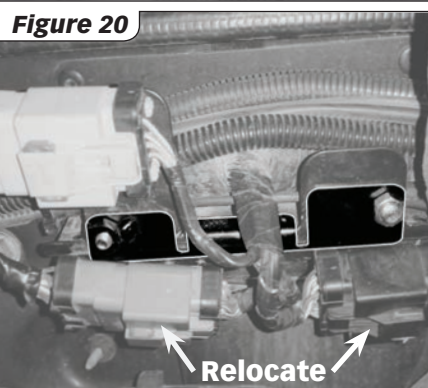
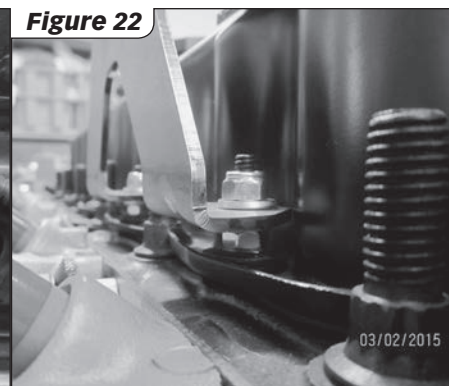
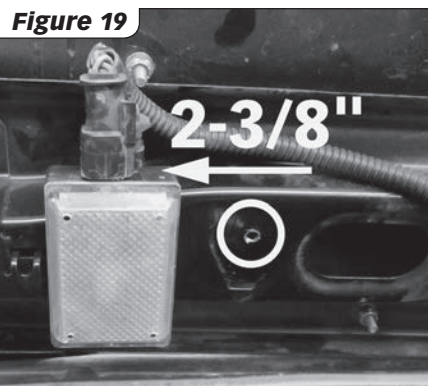
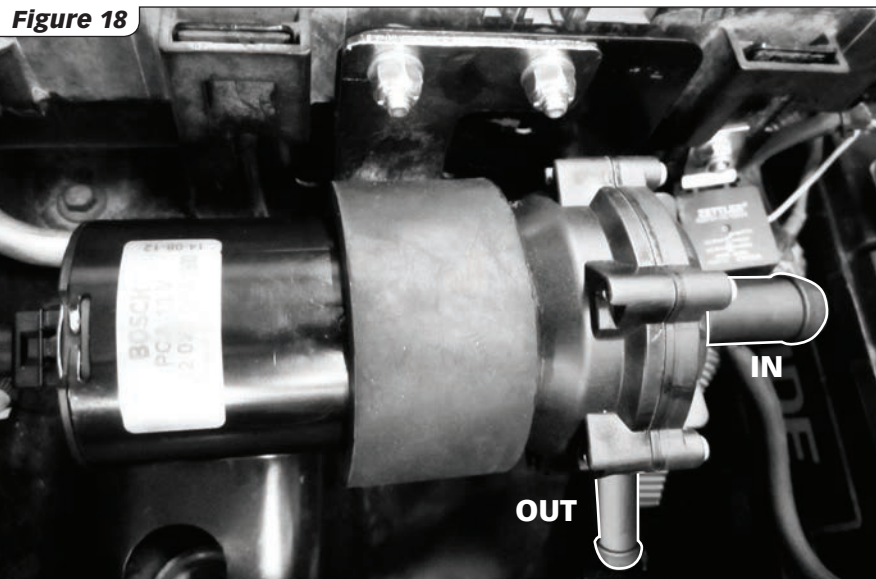

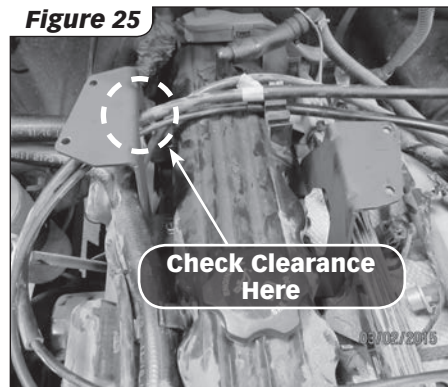

Figure 25

Check Clearance Here

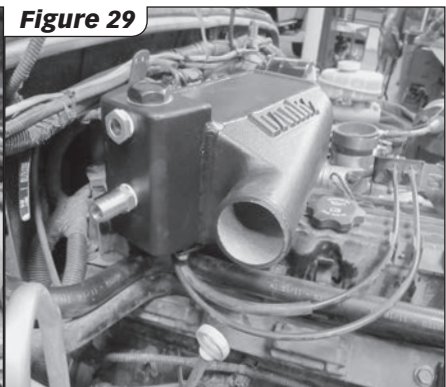

Figure 29

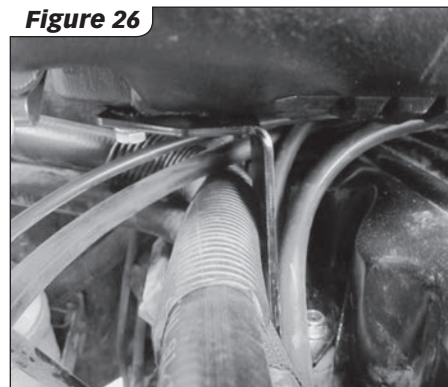

Figure 26

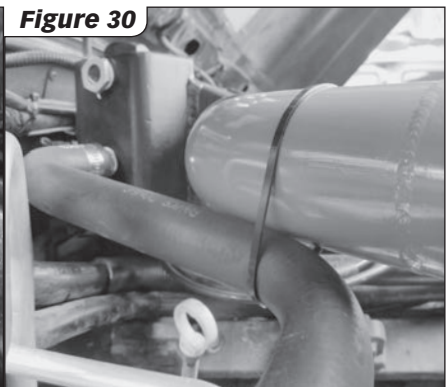

Figure 30

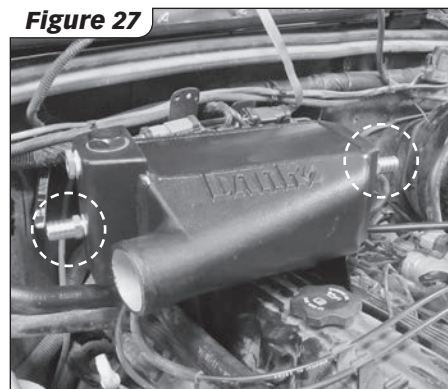

Figure 27

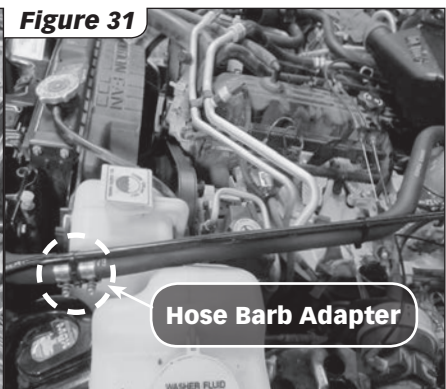

Figure 31

Hose Barb Adapter

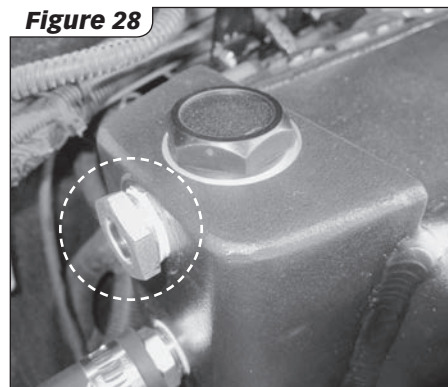

Figure 28

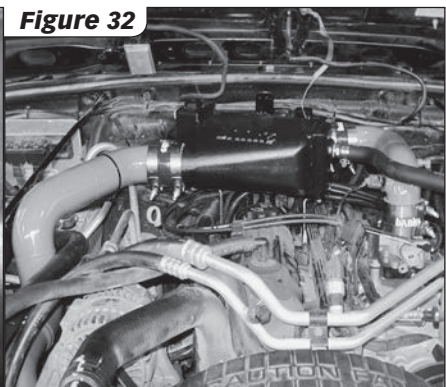



Figure 32

8. Check throttle cable and cruise control cable clearance to the Techni-Cooler brackets, adjust by sliding the cables to create at least 1/2" of clearance. **See Figure 25**

9. Check heater hose clearance to the Techni-Cooler brackets, cover with corrugated loom to protect hose from the sheet metal edge. **See Figure 26**

10. Install straight barbed fittings (P/N 92188) into Techni-Cooler using 2 layers of thread sealing tape (P/N 91099). Tighten 2-3 turns past finger-tight. **See Figure 27**

See Figure 27

 7/8" socket

NOTICE: Do NOT over-tighten fittings.

11. Install sight glass (P/N 25417), if not already installed, into Techni-Cooler using 2 layers of thread sealing tape. Tighten 2-3 turns past finger-tight. **See Figure 28**

See Figure 28

 15/16" socket

NOTICE: Do NOT over-tighten sight glass.

12. Install Techni-Cooler onto brackets using 5/16"-18 bolts (P/N 91271) and washers (P/N 91202) using threadlocker. **See Figure 29**

See Figure 29

 1/2" socket

PLUMBING INSTALL

1. Install Techni-Cooler to pump inlet hose (P/N 94269) and secure with clamps (P/N 92810). Secure hose to boost tube using double-loop tie wrap (P/N 62008). **See Figure 30**

 8 mm nut driver

2. Install hose barb adapter (P/N 92191) and barb to Techni-Cooler inlet hose (P/N 94268-07) and secure with clamps (P/N 92810). Secure hose to radiator support rod using tie wrap (P/N 62001). **See Figure 31**

 8 mm nut driver

3. Install Techni-Cooler inlet boost tube using silicone hose (P/N 94262) and clamps (P/N 92855). Use throttle body silicone hose and clamp from turbo kit. **See Figure 32**

4. Install Techni-Cooler outlet boost tube using silicone hose (P/N 94262) and clamps (P/N 92855). Use compressor-side silicone hose and clamp from turbo kit. **See Figure 33**

5. Install intake air temperature (IAT) sensor and barbed elbow (from turbo kit) into the outlet boost tube. Plug water-methanol injection port if not used. Connect intake air temperature sensor connector. **See Figure 33**

6. Install wastegate reference hose (P/N 94123) from wastegate barb to boost tube barbed elbow using clamps (from turbo kit). **See Figures 34 & 35**

7. Connect power (red) lead of wire harness to fuse box power post and ground (black) lead to the battery ground terminal. Reconnect the battery. **See Figure 36**

8. Fill Techni-Cooler reservoir using funnel with automotive coolant such as Prestone® 50/50 prediluted antifreeze (or equivalent) fill to top, leaving room for cap.

9. Cycle the ignition to ON without starting the vehicle to run the pump and circulate coolant through the system. Check the system for coolant leaks.

10. Check the coolant level and add coolant if needed.

11. Repeat steps 9 and 10 until the coolant level stays in the center of the sight glass.

12. Place cap onto Techni-Cooler.

NOTICE: Do NOT over-tighten cap.

13. Start vehicle and allow to idle. Check the system for coolant leaks. Shut down vehicle.

14. Replace both radiator support rods.

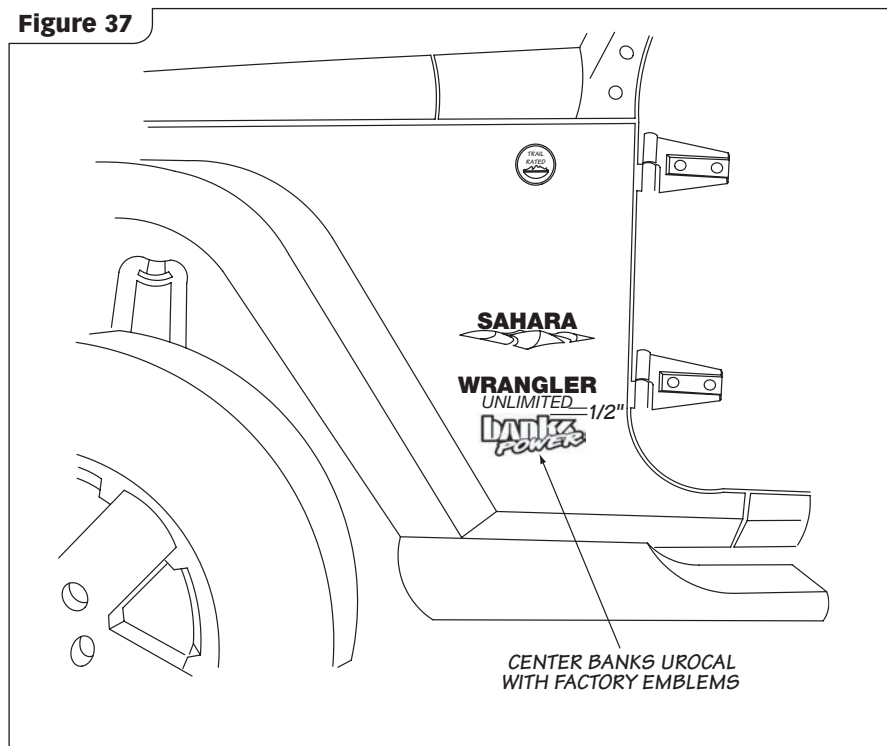
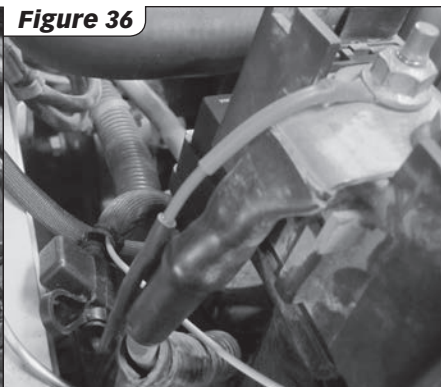
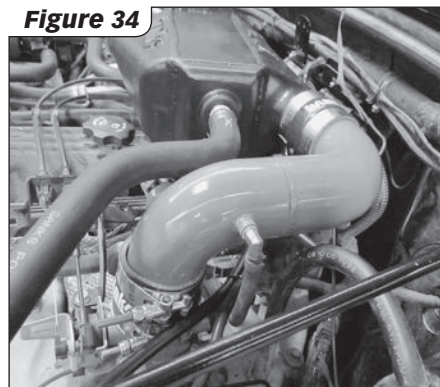
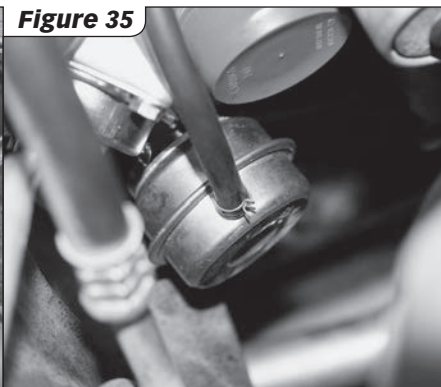
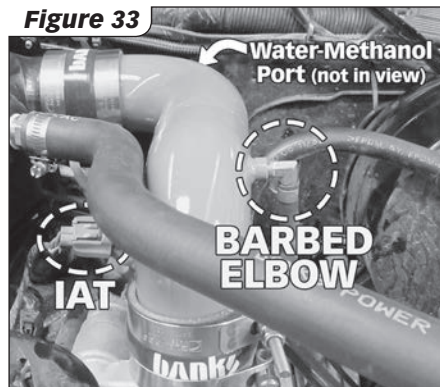

15. Your system includes two (2) Banks Power logos designed to complement the vehicle's front fenders. **See Figure 37** for recommended logo placement.

16. The Banks Techni-Cooler installation is now complete.

Parts List

Part #	Description	Qty
25402	Technicooler Upgrade System, Jeep Wrangler 4.0L Sidewinder, 05-06	1
25400	Technicooler Upgrade System, Jeep Wrangler 4.0L Sidewinder, 99-04	1
25407	Intercooler Kit - 1999-06 Jeep 4.0L Wrangler	1
25404	Techni-Cooler Assembly - Jeep Wrangler, 4.0L	1
25405-05	Mounting Bracket, Left, Zinc plated, 1999-2006 Jeep Wrangler Intercooler	1
25405-07	Mounting Bracket, Right, Zinc plated, 1999-2006 Jeep Wrangler Intercooler	1
25406	Plug, External Hex, M26 x 1.5, O-ring	1
92188	Fitting, Straight, 1/2" NPT Male to 3/4" Hose Barb	2
91271	Hex Bolt, Flange Head, 5/16" -18 x 3/4", Grade 8	4
91202	Washer, Sae Flat, Zinc - 5/16"	4
91193	Stud, Internal Hex Drive, 1/4"-20 x 2" - 99-06 Jeep 4.0L	4
91102	Washer, Sae Flat, Zinc - 1/4"	4
91160	Nut, Hex Flange, Zinc - 1/4"-20	4
91161	Nut, Hex Flange, 1/4"-20 Nylock	5
25408	Bracket, Relocation, Bulkhead Connectors - Jeep Wrangler, 4.0L	1
91115	Hex Bolt, Grade 5, Zinc - 1/4"-20 X 1/2"	2
25415	Heat Exchanger Kit - 1999-06 Jeep 4.0L Wrangler	1
25411	Low Temp Radiator, Water-Air, 3/4" Hose Barbs	1
25412	Mounting Bracket, Jeep 4.0L LTR, with studs	1
25413	Isolator, Lower, Jeep 4.0L LTR, 3/8" ID, no shoulder washer	2
25414	Isolator, Upper, Jeep 4.0L LTR, 1/4" ID shoulder washer	2
91161	Nut, Hex Flange, 1/4"-20 Nylock	2
91103	Washer, Uss, Zinc - 1/4"	2
91164	Well nut, 1/4"-20, 0.5" OD x 0.63" Length	4
25400-1	Boost Tube Kit, Intercooler Upgrade - 1999-04 Jeep 4.0L Wrangler	1
42451	Boost Tube-1, Intercooled Turbo System - 99-06 Jeep 4.0L	1
42453	Boost Tube-2, Intercooled Turbo System - 1999-04 Jeep 4.0L	1
94272	Hose, 2.5" X 2.5", Black - Various Applications	2
92855	Hose Clamp, T-Bolt Style - 3"	4
94123	Hose, Silicone, Black - 1/4" ID X 7/16" OD Bulk	4
25402-1	Boost Tube Kit, Intercooler Upgrade - 2005-06 Jeep 4.0L Wrangler	1
42451	Boost Tube-1, Intercooled Turbo System - 99-06 Jeep 4.0L	1
42454	Boost Tube-2, Intercooled Turbo System - 2005-06 Jeep 4.0L	1
94272	Hose, 2.5" X 2.5", Black - Various Applications	2
92855	Hose Clamp, T-Bolt Style - 3"	2
94123	Hose, Silicone, Black - 1/4" ID X 7/16" OD Bulk	4
25420	Water Pump & Plumbing Kit - CAC, 1999-06 Jeep 4.0L Wrangler	1
25419	Pump, Water, Jeep Wrangler 4.0L CAC	1
94267	Hose, Pump to LTR	1
94268-05	Hose, LTR to Barb	1
94268-07	Hose, Barb to CAC	1

94269	Hose, CAC to Pump	1
92191	Fitting, Union, 3/4" to 3/4" Hose Barb	1
93655	Grommet, Pass-through, 1.25" ID	2
92810	Hose Clamp, #10	8
W-CCL-100	Corrugated Loom, Nylon, 1" Id	5
25418	Mounting Bracket, Water Pump, Jeep 4.0L CAC	1
91171	Hex Bolt. Flange Head, 1/4" -20 x 5/8", Grade 8	2
91161	Nut, Hex Flange, 1/4"-20 Nylock	2
25424	Harness Kit, 1999-06 Jeep 4.0L Wrangler	1
62802	Harness w/ Relay, inline fuse holder, pump connector	1
91171	Hex Bolt. Flange Head, 1/4" -20 x 5/8", Grade 8	2
91161	Nut, Hex Flange, 1/4"-20 Nylock	2
62032	Connector, T-Tap, Blue - 16-14 Gauge	1
25400-9	Owners Manual & Installation Kit, CAC - 99-06 Jeep 4.0L	1
96314	Owner's Manual - Techni-cooler Upgrade Syst, 1999-06 Jeep Wrangler, 4.0L	1
62001	Cable Tie, Black, 6"	10
62003	Cable Tie, Black, 13"	5
62008	Cable Tie, White, Double Loop, 15.5"	1
62006	Cable Tie, Black, Push Mount, 8"	1
90001	Threadlocker, Blue .5MI	1
91099	Teflon Tape, 1/2" X 100"	1
92251	1/8" pipe plug	1
96009	Banks Urocal Sticker	2
96399	Registration Card	1

Gale Banks Engineering
546 Duggan Avenue • Azusa, CA 91702
(626) 969-9600 • Fax (626) 334-1743

Product Information & Sales: (888) 635-4565
Customer Support: (888) 839-5600
Installation Support: (888) 839-2700

bankspower.com