

GM 2019 Silverado / Sierra 1500 Performance Cat Back Exhaust

Congratulations on your purchase of a Rough Country Performance Exhaust System

Please read instructions before beginning installation. Check the kit hardware against the kit contents shown below. Be sure you have all needed parts and know where they go.

If question exist, please call us @1-800-222-7023. We will be happy to answer any questions concerning this product.

Check all fasteners for proper torque. Check to ensure for adequate clearance between all components.

Allow the stock exhaust to cool before removal. Periodically check all hardware for tightness.

Allow adequate time for the exhaust to cool before disassembly.

Fits: 5.3L 5.8' & 6.6' bed Crew Cab and Double Cab Vehicles with factory rear dual exhaust.

This kit allows the option to retain the factory dual tips if desired

NOTICE: Please see info below for various wheelbase options.

148" WB Crew Cab - 5.8' Bed. Use tube "A" only.

145" WB Crew Cab - 6.6' Bed. Use tube "A" & "B"

148" WB Double Cab - 6.6' Bed. Use tube "A" only.

KIT CONTENTS:

Inlet Tube x1 (A)

Exhaust Extension Tube x 1 (B)

Muffler x 1 (C)

DR Side Mid Tube x 1 (D)

Pass Side Mid Tube x 1 (E)

Dr Side Exit Tube x 1 (F)

Pass Side Down Tube x 1 (G)

Exit Tubes W/ (Black) Exhaust Tips x 2 (H)

HARDWARE INCLUDED:

2.5" Exhaust Clamps x 6

3" Exhaust Clamp x 2

1/2" Hanger Retainer x 5

TOOLS NEEDED:

10mm Wrench / Socket

13mm Wrench / Socket

15mm Wrench /Socket

16mm Wrench or Socket

Torque Specs:

Size	Grade 5	Grade 8	Size	Class 8.8	Class 10.9
5/16"	15 ft/lbs	20ft/lbs	6MM	5ft/lbs	9ft/lbs
3/8"	30 ft/lbs	35ft/lbs	8MM	18ft/lbs	23ft/lbs
7/16"	45 ft/lbs	60ft/lbs	10MM	32ft/lbs	45ft/lbs
1/2"	65 ft/lbs	90ft/lbs	12MM	55ft/lbs	75ft/lbs
9/16"	95 ft/lbs	130ft/lbs	14MM	85ft/lbs	120ft/lbs
5/8"	135ft/lbs	175ft/lbs	16MM	130ft/lbs	165ft/lbs
3/4"	185ft/lbs	280ft/lbs	18MM	170ft/lbs	240ft/lbs



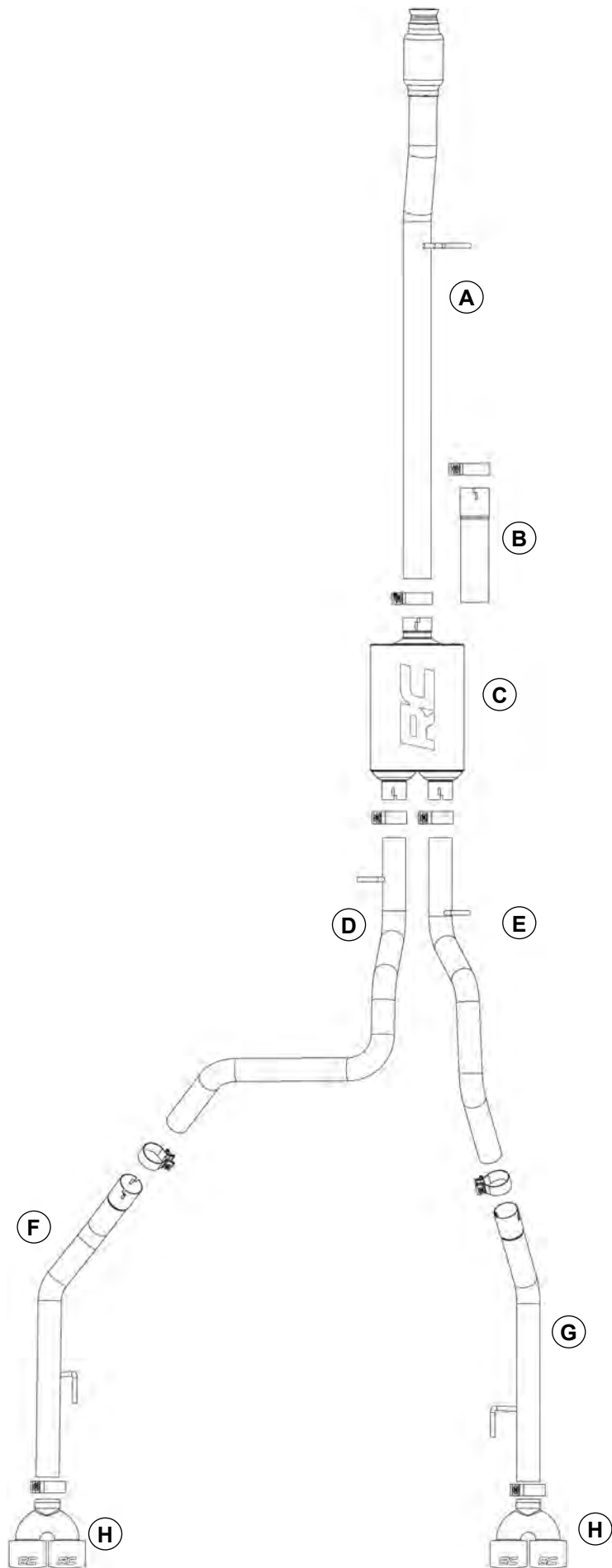

INSTALLATION INSTRUCTONS

1. This exhaust system gives the option of retaining the factory chrome exhaust tip shown in **Photo 1** or installing the Rough Country dual exhaust black tip as shown in **Photo 2**.
2. Skip to **Step 6** if the factory chrome exhaust tips will be retained for this install.

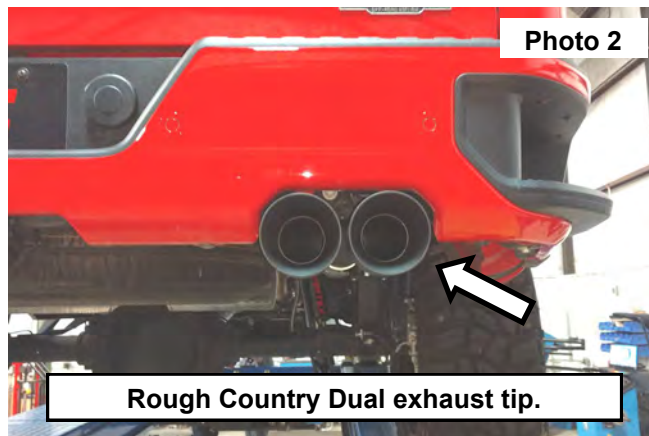
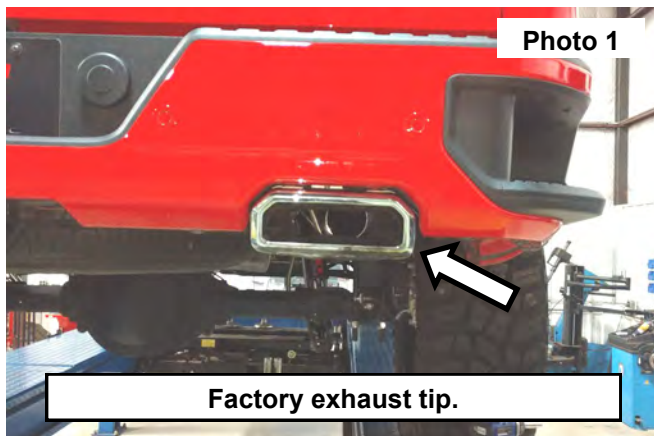

3. Using a 10mm wrench remove the 2 bolts in the top of the exhaust tip from the bumper. **See Photo 3.**
4. Using a 10mm socket and ratchet remove the upper bolt from the exhaust tip, then remove the tip from the rear bumper. **See Photo 4.**
5. Repeat this process on the opposite side of the vehicle to remove both rear exhaust tips.

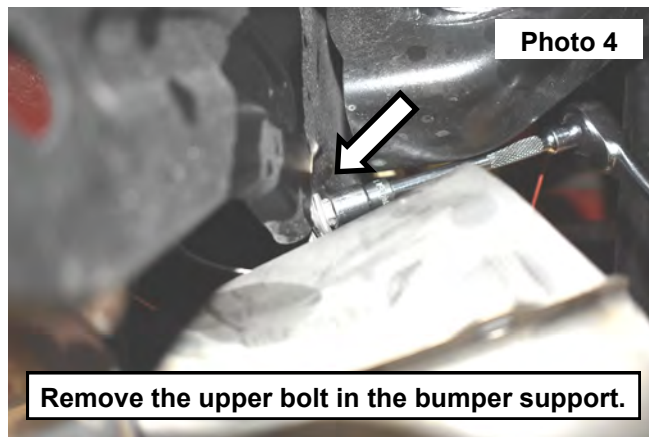
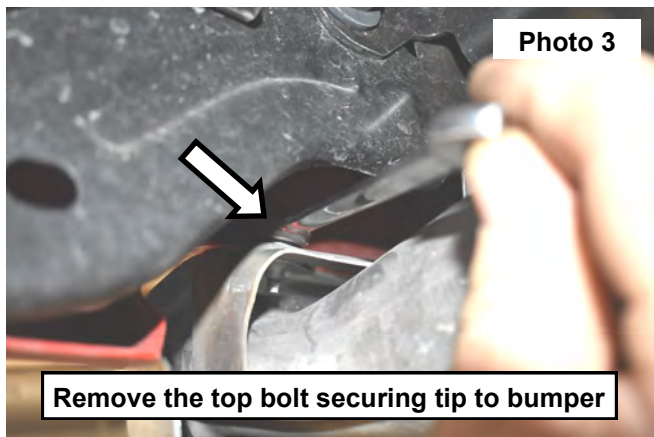

6. Using a 15mm wrench remove the exhaust tube mounts on each side of the frame. Retain the 2 bolts and the 2 mounts for later use. **See Photos 5 and 6.**

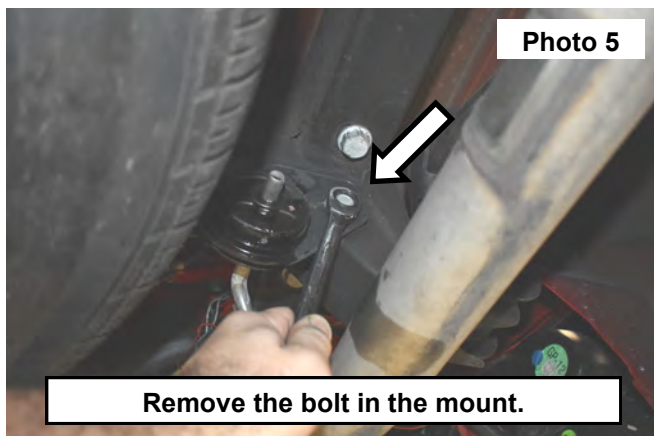

- Remove the 2 nuts from the studs on the left rear down tube connection using a 13mm wrench. **See Photo 7.**
- Remove the down tube. **See Photo 8.**

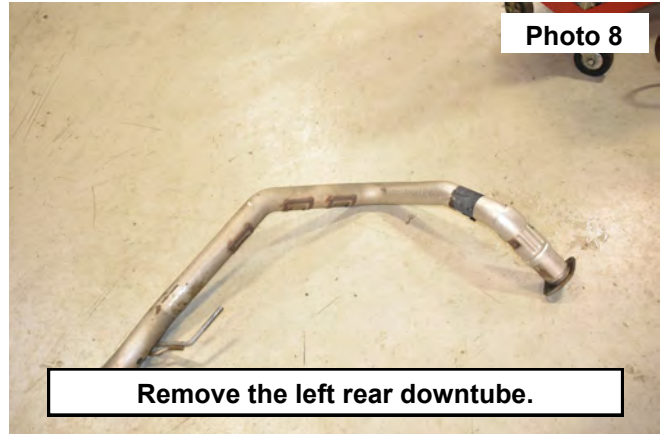

- Loosen the clamp on the flex tube to the engine exit tube using a 13mm wrench. **See Photo 9.**
- Use a pry tool to remove the exhaust mounts from the rubber hangers in the front of, and behind the muffler. **See Photo 10.** Do not remove the rubber hanger from the vehicle these will be reused.

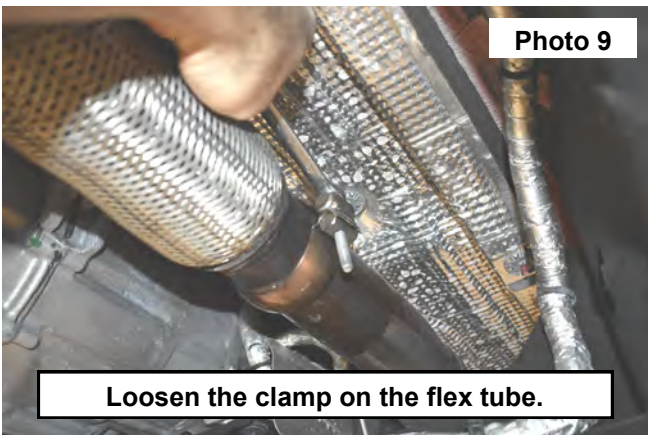

- Once the exhaust has been removed from the 3 rubber hanger mounts, separate at the flex tube clamp shown in **Photo 11** and carefully remove the exhaust. **See Photo 12** shows the location of the stock hangers.

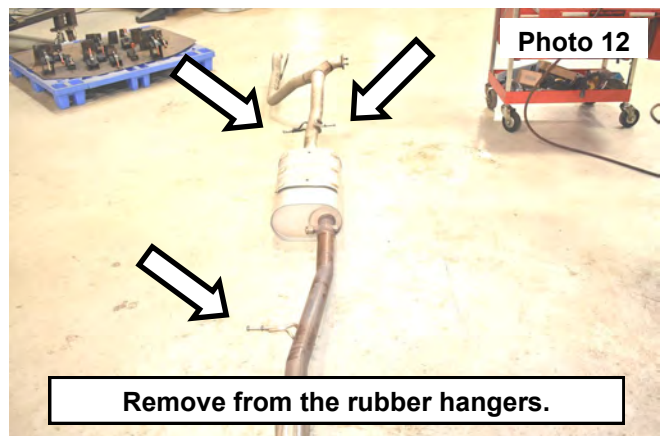
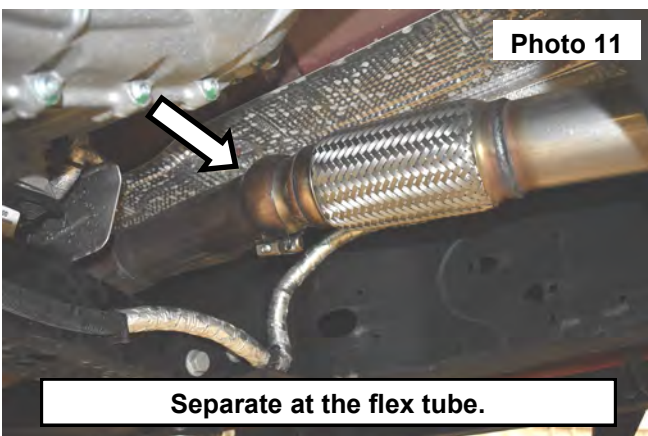

12. Using long nose pliers raise the tab up and remove the clamp for reuse from the flex tube. **See Photo 13.**
13. Install the OE clamp onto the new inlet tube and install onto the vehicle using the rubber hanger. **See Photo 14.**

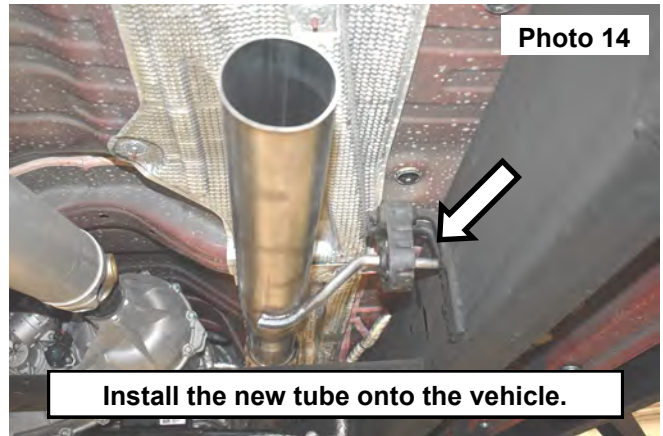
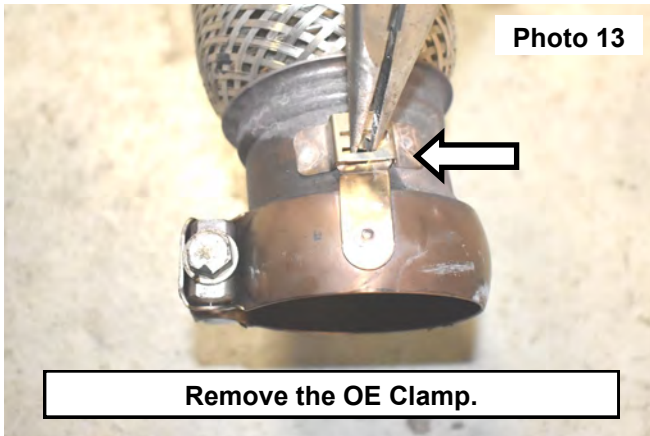

14. If installing on Crew Cab w/ 6.6' bed, Install (1) 3" clamp onto the extension tube "B", then install onto the inlet tube, snug the clamp using a 16mm socket. **See Photo 15.**
15. Use a stand to support the muffler under the vehicle. Install a 3" clamp onto the inlet side of the muffler and install onto the extension tube. **See Photo 16.**

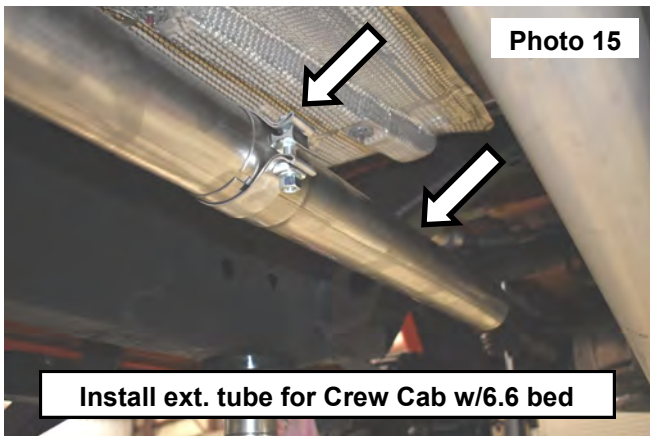

16. Install (1) 2 1/2" clamp onto each exit flange of the muffler. **See Photo 17.**
17. Install the Passenger side exit tube into the muffler then install the tube mount into the rubber mount. **See Photo 18.**

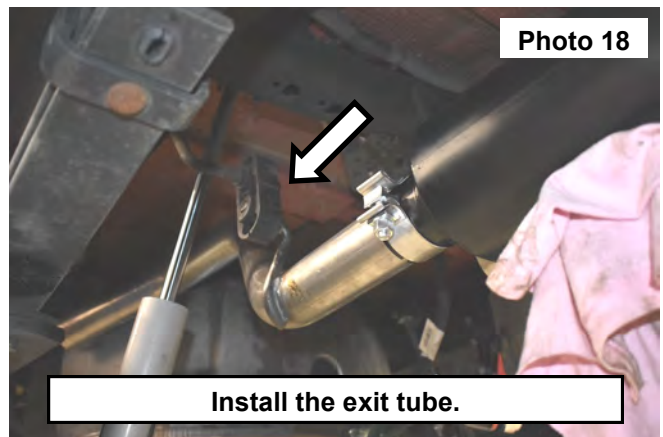
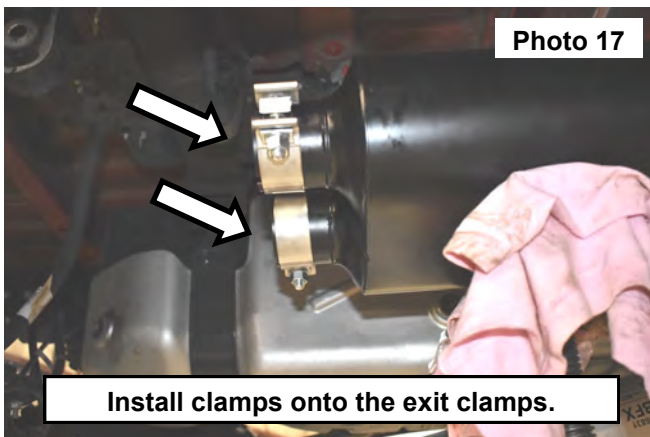

18. Install the Driver side exit tube into the muffler then install the tube mount into the rubber mount. **See Photo 19.**
19. Install (1) 2 1/2" clamp on the rear exit tubes, **NOTE: if the exhaust is being installed with the factory exhaust tip.** Install the exit tube into the exhaust tip first then into the exit tube, **NOTE: if not using the factory exhaust tips install clamp and tube.** **See Photo 20 and 21.** Repeat step on opposite side of the vehicle.

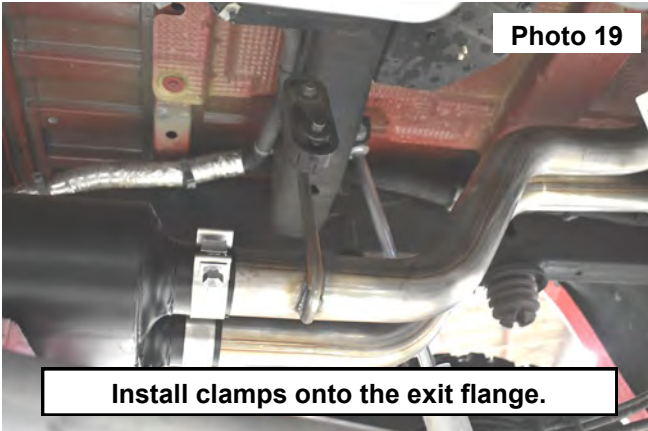

Install clamps onto the exit flange.

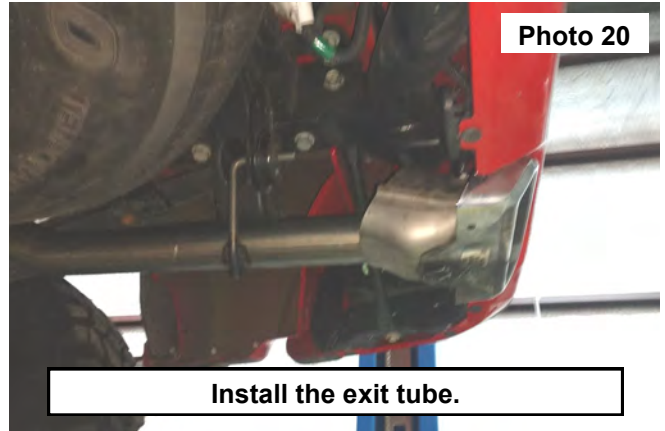

Install the exit tube.

20. Install the rubber mount onto the tube mount, then install onto the frame in the original location, secure using the retained hardware. Tighten using a 13mm socket. **See Photo 21.** Repeat on the opposite side of the vehicle.

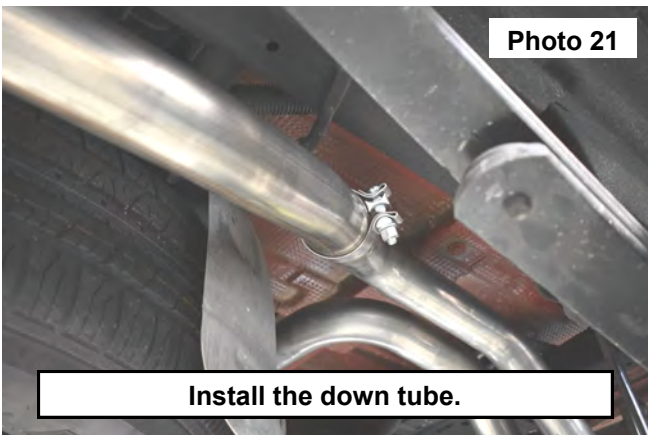

Install the down tube.

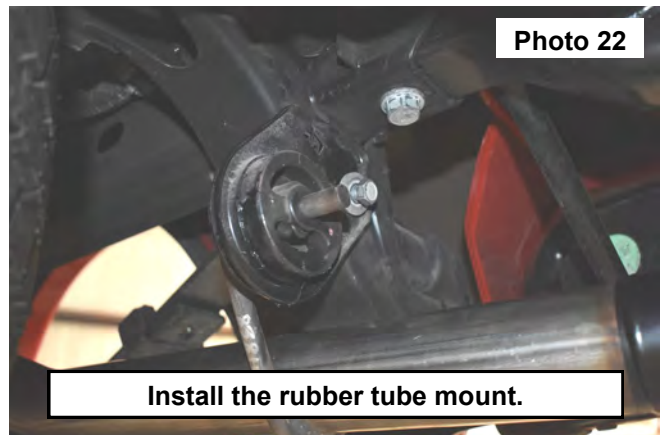

Install the rubber tube mount.

21. **NOTE: If installing the dual exhaust tips.** Install a clamp onto the flange of the exhaust tip, then install onto the rear of the exit tube. **See Photo 23.**
22. Check to insure its aligned with the bumper and has clearance on each side of the tip. Then tighten the clamp using a 16mm socket. **See Photo 24.**

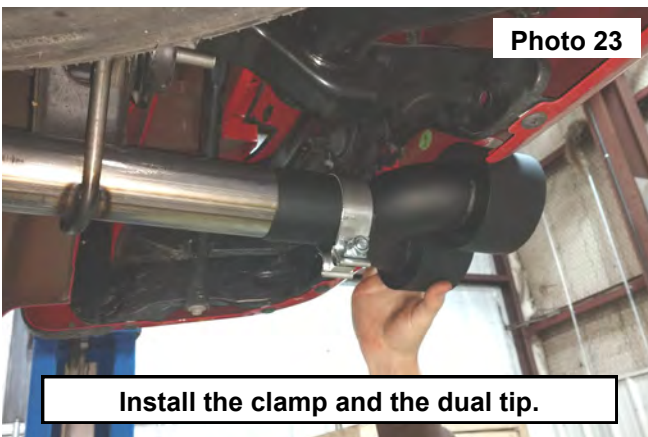

Install the clamp and the dual tip.

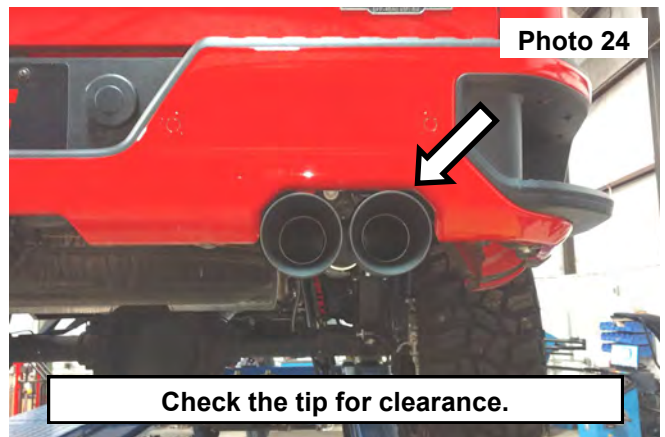

Check the tip for clearance.

23. **Adjust as necessary and tighten all clamps.**

By purchasing any item sold by Rough Country, LLC, the buyer expressly warrants that he/she is in compliance with all applicable, State, and Local laws and regulations regarding the purchase, ownership, and use of the item. It shall be the buyers responsibility to comply with all Federal, State and Local laws governing the sales of any items listed, illustrated or sold. The buyer expressly agrees to indemnify and hold harmless Rough Country, LLC for all claims resulting directly or indirectly from the purchase, ownership, or use of the items.

