

# ROUGH COUNTRY

## SUSPENSION SYSTEMS



# 557INSTRBAG1

27.11  
(688.7 mm)

## FORD 2021 F-150 6" Lift Kit

### THANK YOU FOR CHOOSING ROUGH COUNTRY FOR YOUR SUSPENSION NEEDS.

Rough Country recommends a certified technician install this system. In addition to these instructions, professional knowledge of disassemble/reassembly procedures as well as post installation checks must be known. Attempts to install this system without this knowledge and expertise may jeopardize the integrity and/or operating safety of the vehicle.

Please read instructions before beginning installation. Check the kit hardware against the parts list. Be sure you have all needed parts and know where they go. Also please review tools needed list and make sure you have needed tools.

#### PRODUCT USE INFORMATION

**▲WARNING** The taller a vehicle is, the easier it will roll. We strongly recommend, because of rollover possibility that seat belts and shoulder harnesses should be worn at all times. Avoid situations where a side rollover may occur.

**▲WARNING** Generally, braking performance and capability are decreased when larger/heavier tires and wheels are used. Take this into consideration while driving. Do not add, alter, or fabricate any factory or after-market parts to increase vehicle height over the intended height of the Rough Country product purchased. Mixing component brands is not recommended.

Rough Country makes no claims regarding lifting devices and excludes any and all implied claims. We will not be responsible for any product that is altered. If questions exist we will be happy to answer them concerning the design, function, and correct use of our products.

The 6" suspension system was developed using a 35X12.50/20 tire with 20 x 9 wheel with 4 1/2" backspace. The lifts were designed to lift the front to level the vehicle. Due to manufacturing, dimension variances, and inflation all tire and wheel combinations should be tested prior to installation on all oversized / wider then stock tires. We recommend using a 20" minimum wheel with corresponding tire, 9" in width with a minimum backspacing of 4.5" to a maximum of 5". When using a stock wheel, it must be 20" or larger and the maximum tire width is 11 1/2".

**▲NOTICE** Vehicles will require the EPAS (Electronic Power Assist Steering) plugs to be disconnected prior to beginning installation of this kit. See installation instructions. Failure to disconnect these plugs may result in damage to the EPAS module resulting in an error message being displayed, which will require replacement of the EPAS module

#### ▲NOTICE DEALER AND VEHICLE OWNER

Any vehicle equipped with any Rough Country product should have a "Warning to Driver" decal installed on the inside of the windshield or on the vehicle's dash. The decal should act as a constant reminder for whoever is operating the vehicle of its unique handling characteristics.

#### Tools Needed:

3/32" Allen Wrench	Floor Jack
11/32" Socket	Jack stands
5mm Allen Wrench	Reciprocating Saw
8mm Allen Wrench	Hammer
8mm wrench /socket	9/16 wrench /socket
10mm wrench /socket	1 1/16" Wrench
12mm Wrench	Drill
13mm wrench / socket	1/4" Drill Bit
15mm wrench /socket	5/8" Drill Bit
16mm wrench /socket	11/32" Drill Bit
18mm wrench /socket	Torque Wrench
19mm wrench /socket	Trim Remover Tool
21mm wrench /socket	
22mm wrench /socket	
24mm wrench /socket	
30mm wrench /socket	
T45 Torx Bit	

#### Torque Specs:

Size	Grade 5	Grade 8
5/16"	15 ft/lbs	20 ft/lbs
3/8"	30 ft/lbs	35 ft/lbs
7/16"	45 ft/lbs	60 ft/lbs
1/2"	65 ft/lbs	90 ft/lbs
9/16"	95 ft/lbs	130 ft/lbs
5/8"	135 ft/lbs	175 ft/lbs
3/4"	185 ft/lbs	280 ft/lbs
	Class 8.8	Class 10.9
6MM	5 ft/lbs	9 ft/lbs
8MM	18ft/lbs	23 ft/lbs
10MM	32ft/lbs	45ft/lbs
12MM	55ft/lbs	75ft/lbs
14MM	85ft/lbs	120ft/lbs
16MM	130ft/lbs	165ft/lbs
18MM	170ft/lbs	240ft/lbs



## 6" KIT CONTENTS

### 58730 (6" Kit w/ N3 Shocks):

587BOX1  
587BOX2  
587BOX3  
587BOX4  
557BOX3

### 58731 (6" Kit w/ N3 Struts and N3 Shocks):

587BOX1  
587BOX2  
587BOX3  
587BOX4  
501052  
23165

### 58771 (6" Kit w/ N3 Struts and V2 Shocks):

587BOX1  
587BOX2  
587BOX3  
587BOX4  
501052  
760751



## KIT CONTENTS

### **587BOX1:**

1-Front Crossmember  
1-Rear Crossmember

### **587BOX2:**

1-Dr Side Knuckle  
1-Pass Side Knuckle

### **587BOX3:**

1-1263BAG2  
8-7/16" Flat Washers  
4-Ubolts (Small)  
8-7/16"-14 Lock Nuts  
4-Ubolts (Large)  
2-Rear Blocks  
8-Rear Block Shims  
2-Rear Bump Stop Brackets  
1-Rear Brake Line Bracket

### **587BOX4:**

4-Cam Bolts  
1-1556BAG2  
2-Ubolts  
4-3/8"-16 Flange Lock Nuts  
1-587BAG1 (Hardware)  
9-3/8" Flat Washers  
5-3/8"-16x1" Bolts  
3-3/8"-16 Lock Nuts  
4-5/16" Flat Washers  
2-5/16"-18x0.75" Bolts  
2-5/16"-18 Lock Nuts  
1-5/16" Vent Hose Coupler  
1-5/16"x4" Vent Hose  
8-7/16" Flat Washers  
4-7/16"-14x1.25" Bolts  
4-7/16"-14 Lock Nuts  
4- #8-32x1/2 Bolts  
4- #8-32 Nuts  
1-1557BAG15  
2-12MM-1.75x35MM Bolts  
2-12MM-1.75 Lock Nuts  
4-1/2" Flat Washers  
1-1557BAG8  
4-3/4" Flat Washers  
2-18MM-2.5x150MM Bolts  
2-18MM-2.5 Lock Nuts  
6-9/16" Flat Washers  
3-9/16"-12x4 Bolts  
3-9/16"-12 Lock Nuts  
2-1/2" Flat Washers  
1-1/2"-13x1.5" Bolt  
1-1/2"-13 Lock Nut  
1-557INSTBAG1  
1-Instructions  
2-Fr Brake Line Brackets  
1-Fr Diff Bracket  
1-Fr Pass Diff Bracket  
1-Pass Diff Brace  
1-Dr Swaybar Drop Bracket  
1-Pass Swaybar Drop Bracket  
1-Fr Skid Plate  
1-Rr Dr Diff Mount  
2-Swaybar Drop Bracket Badge

### **557BOX3:**

1-10MMSTUDBAG-2  
6-10MM-1.25 Stud  
6-10MM-1.25 Flange Nut  
1-10MM-1.25 Nut  
1-1/2" Jam Nut  
2-Rear N3 Shocks  
2-6" Strut Spacers

### **501052:**

1-6" Loaded Strut Pair

### **23165:**

1-Rear N3 Shock Pair

### **760751:**

1-Rear V2 Monotube Shock Pair



6" N3 Kit Shown in Picture





## FRONT INSTALLATION INSTRUCTIONS

1. **NOTE: Make sure vehicle is in 2WD before beginning installation.**
2. Chock the rear wheels and jack up the front of the vehicle.
3. Place jack stands under the frame rails and lower onto jack stands.
4. Remove the wheels/tires using a 21mm socket.
5. Remove the carpet and skid plate with a 13mm socket/wrench. **See Photo 1.**
6. Remove the 3 EPAS (Electronic Power Assist Steering) Plugs on the steering assembly by the front differential. Pull the red tab back to unlock as shown by the middle plug in **Photo 2.**  
**This must be done BEFORE installation is started.**

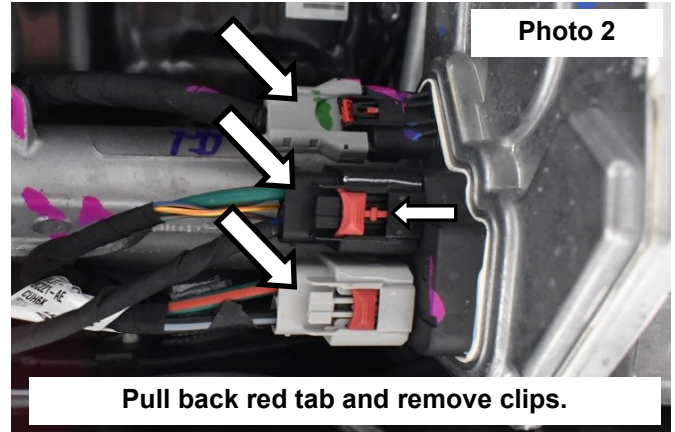
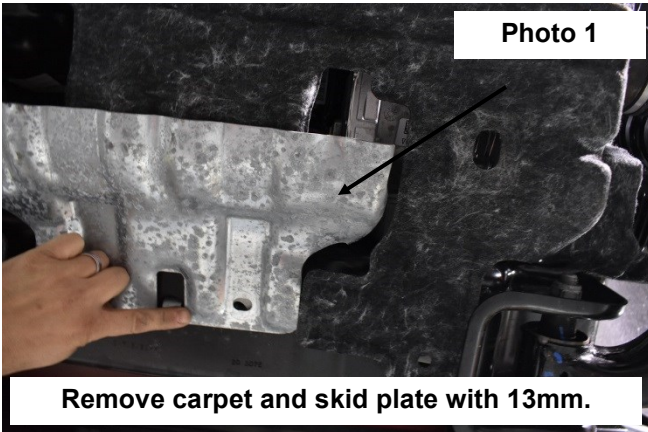

7. Remove tie-rod end using a 21mm wrench. Strike the knuckle with a hammer to loosen the tie rod end. **Photo 3.**
8. Remove ABS line snap clips using a trim remover tool to get more slack in the line. **See Photo 4.**

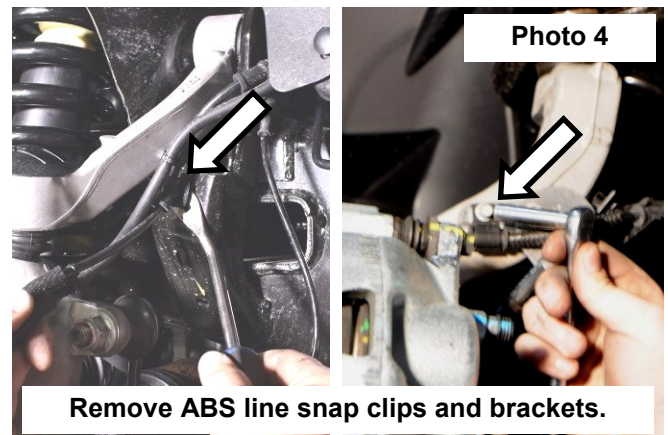
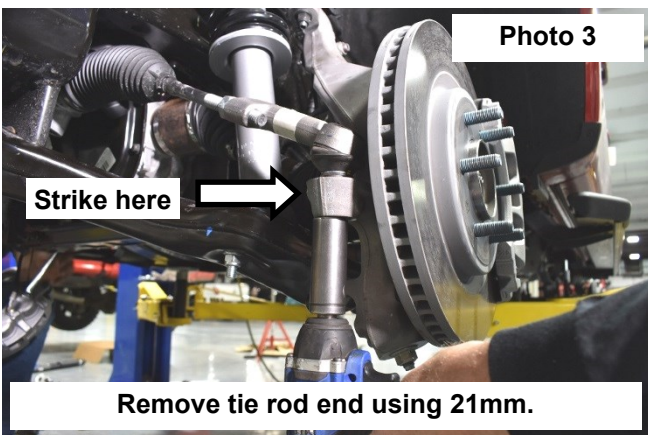

9. Remove the upper ball joint nut using a 18mm socket/wrench. Strike the knuckle to loosen. **See Photo 5.**
10. Using a 21mm socket, remove brake caliper as shown in **Photo 6.** Hang caliper out of way. Do not let caliper hang by brake hose as this will damage hose.

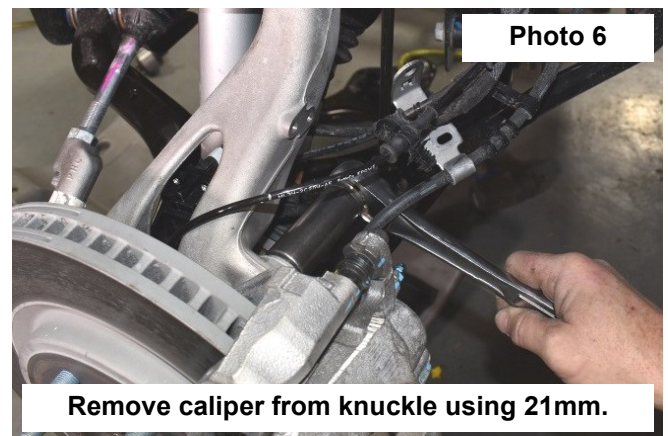
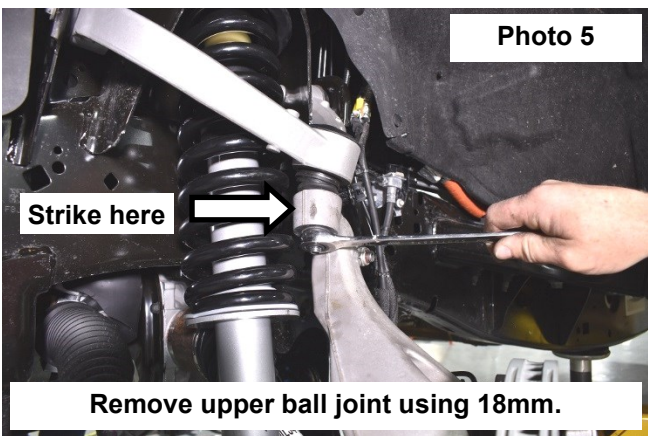



10. Remove the rotor. **See Photo 7.**

11. Remove the ABS wire from the bearing assembly using a 5mm Allen wrench. **See Photo 8.**

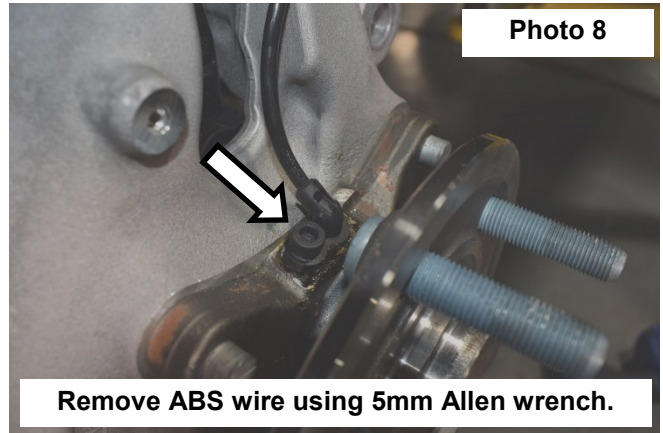
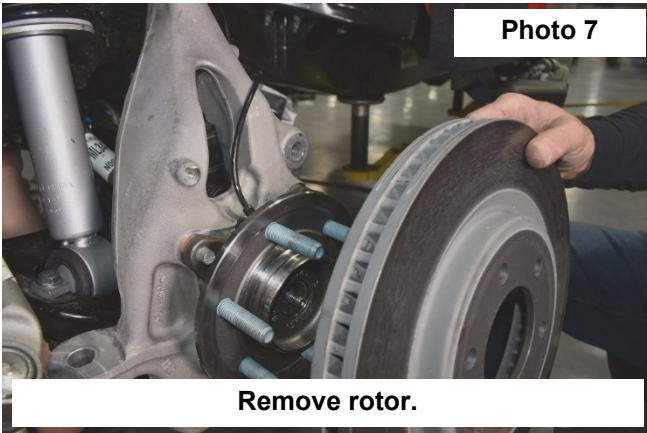

12. Remove the sway bar link using a 21mm wrench and T45 Torx bit. **See Photo 9.**

13. Remove the axle nut using a 13mm socket. Let the knuckle hang. **See Photo 10.**

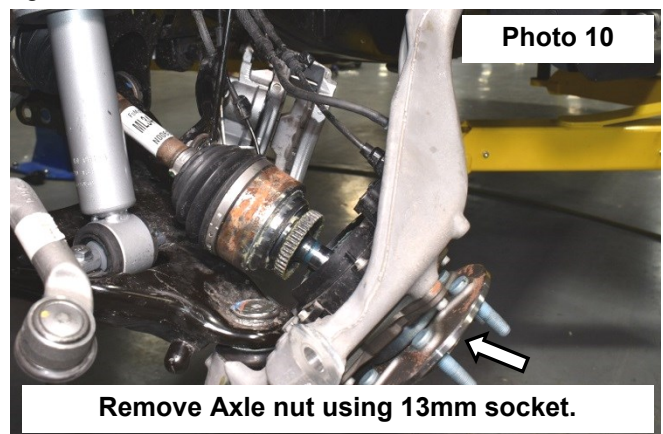
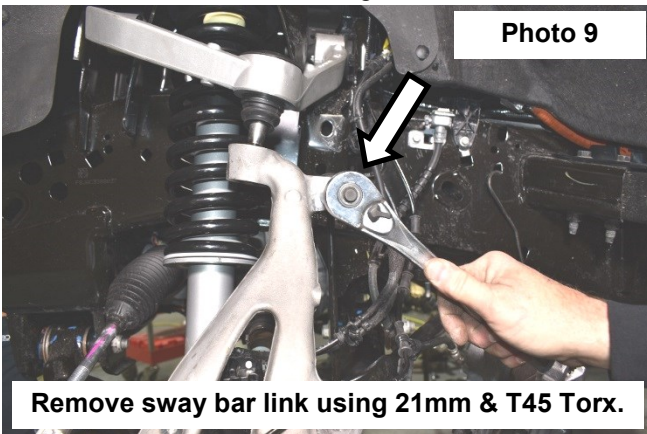

14. Remove actuator using an 8mm socket/wrench. **See Photo 11.**

15. Remove the lower ball joint using a 21mm socket/wrench and remove the knuckle. **See Photo 12.**

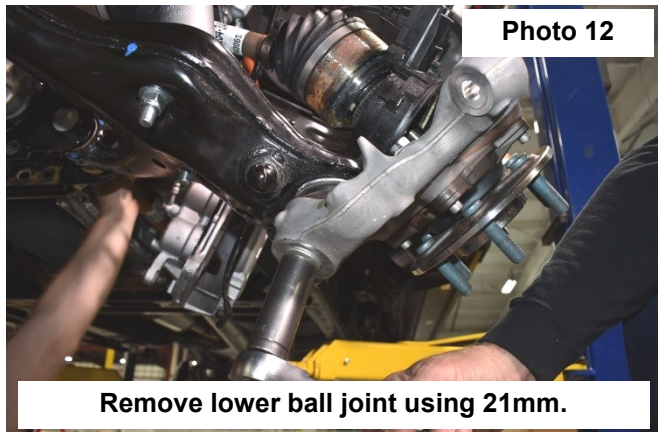
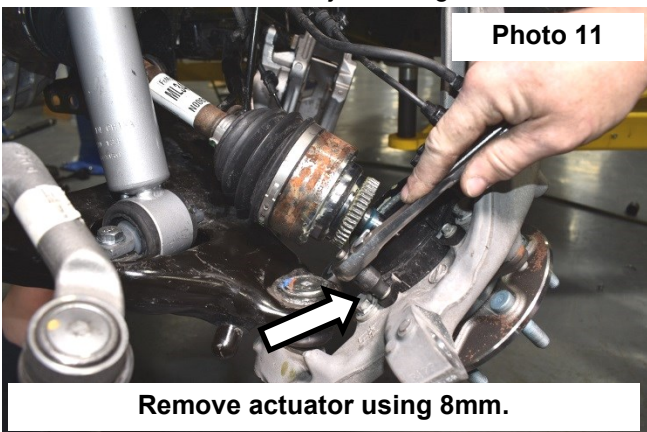



17. Remove the lower strut nuts using an 18mm socket/wrench. **See Photo 13.**

18. Remove the upper strut nuts using a 18mm wrench. **See Photo 14.**

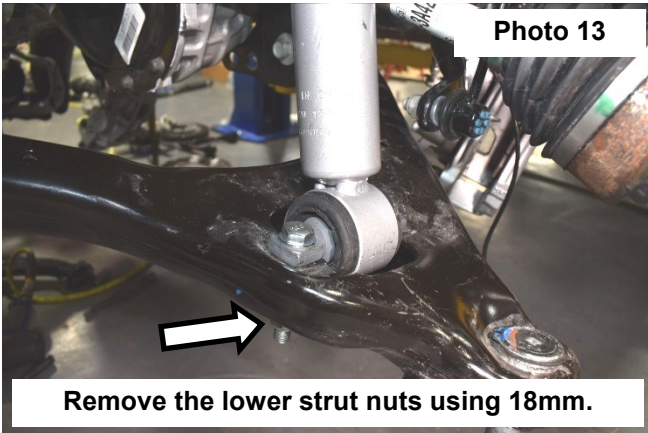

Remove the lower strut nuts using 18mm.

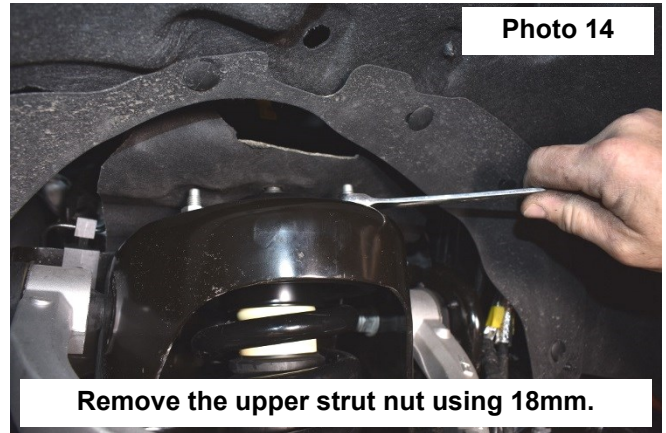

Remove the upper strut nut using 18mm.

19. Remove the strut from the vehicle. **See Photo 15.**

20. Remove the driveshaft from the front differential using a 10mm socket/wrench. **See Photo 16.**

**NOTE: Support or tie up drive shaft. Do NOT let it hang down as this can damage the drive shaft.**

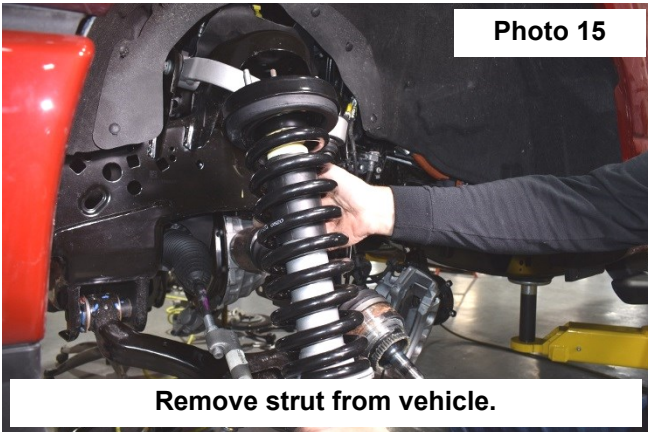

Remove strut from vehicle.

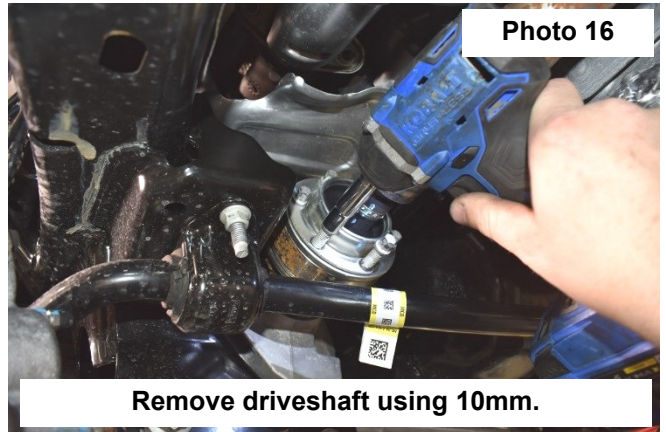

Remove driveshaft using 10mm.

21. Remove the swaybar from the frame using a 15mm socket/wrench. **See Photo 17.**

22. Remove lower control arms using a 27mm socket/wrench on nut and 21mm socket/wrench on bolt. **See Photo 18.**

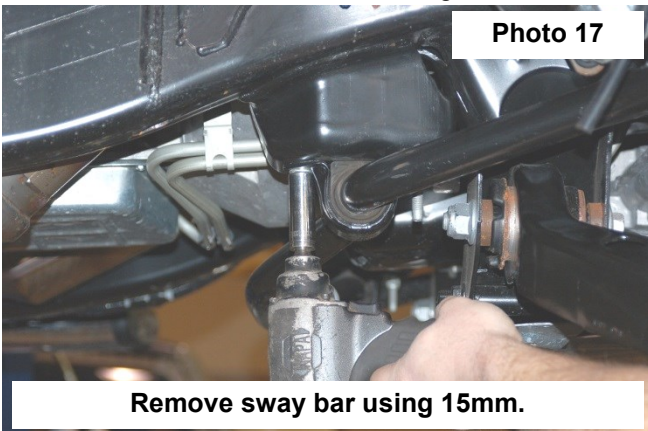

Remove sway bar using 15mm.

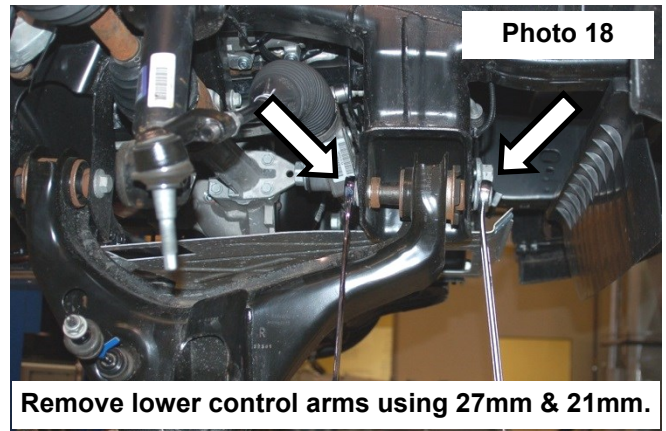

Remove lower control arms using 27mm & 21mm.



23. Remove the stock rear cross-member using a 15mm & 18mm socket. Retain hardware for reuse. **See Photo 19.**  
24. Support the differential using a floor jack and remove the upper driver side differential bolt using a 18mm wrench. **See Photo 20.**

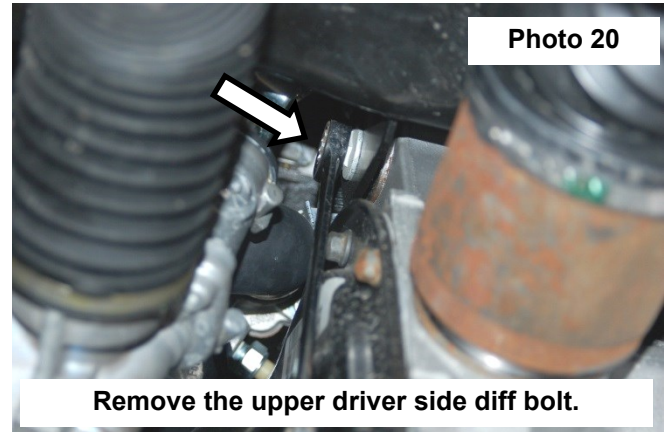
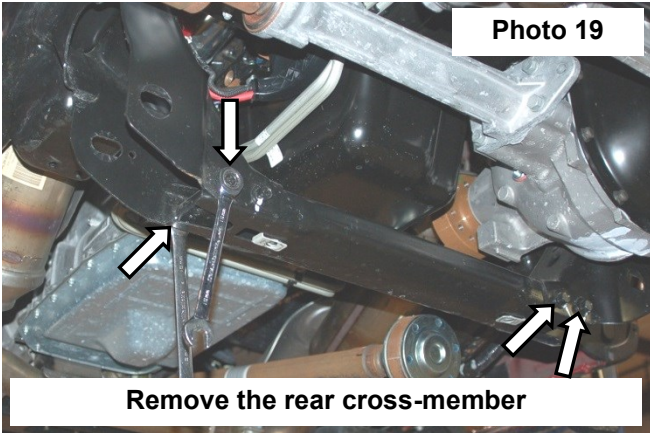

25. Remove the differential vent tube from the differential.  
26. Remove the passenger side differential bolt using a 18mm wrench. **See Photo 21.**  
27. Remove the lower driver side differential bolt using a 18mm socket/wrench. Remove the differential from the vehicle. **See Photo 22.**

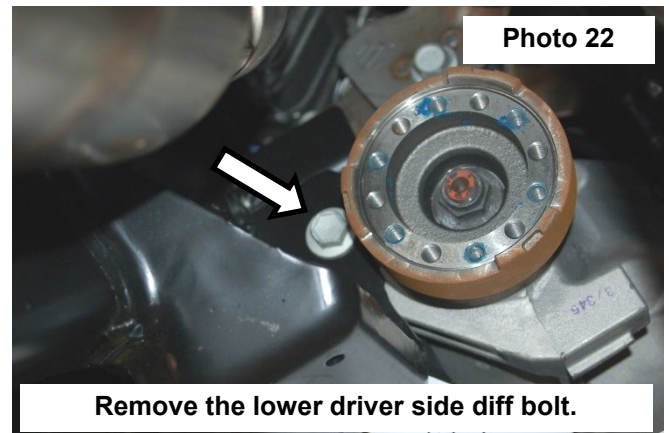
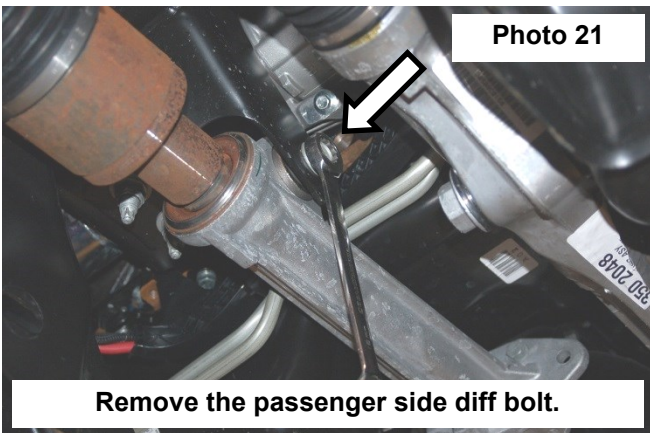

28. Tape supplied cutting template on front and back side of the driver side lower cross-member mount. Using template as a guide, trim cross-member mount using a reciprocating saw to allow differential to be remounted with RC cross-members. **See Photo 23.**  
29. Sand the sharp edges on the frame and paint the edge to prevent rusting. **See Photo 24.**

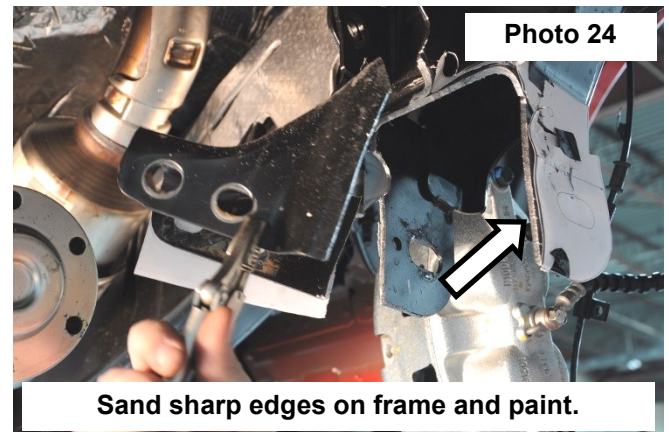
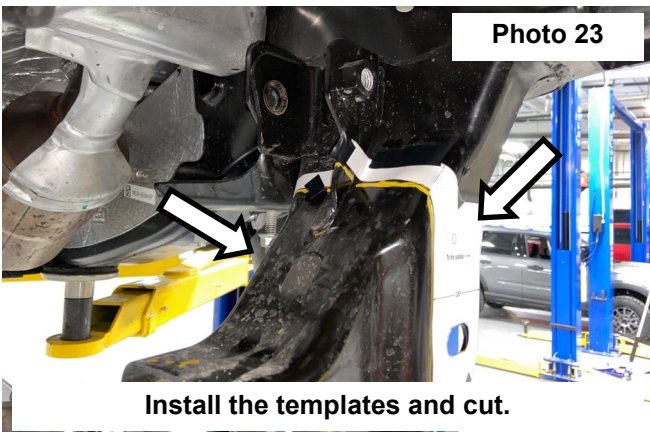



30. Install the new bracket on the passenger side diff mount with the supplied hardware. Install the 9/16" x 4" bolt, washers & nut in the in the passenger side mount. Do not tighten at this time. **See Photo 25.**  
**NOTE: The Pass side diff bracket has 2 notches on the side and the Dr side diff bracket has 3 notches.**
31. Install the front driver side diff mount with the supplied 9/16" x 4" bolt, washers and nut **from the front to rear.**  
**NOTE: The differential mount bolts will need to be inserted from the front of the differential in order to clear the rack and pinion. Do not tighten at this time. See Photo 26.**

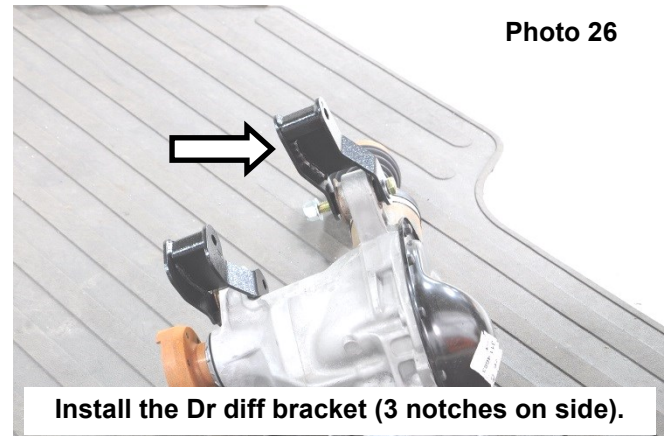
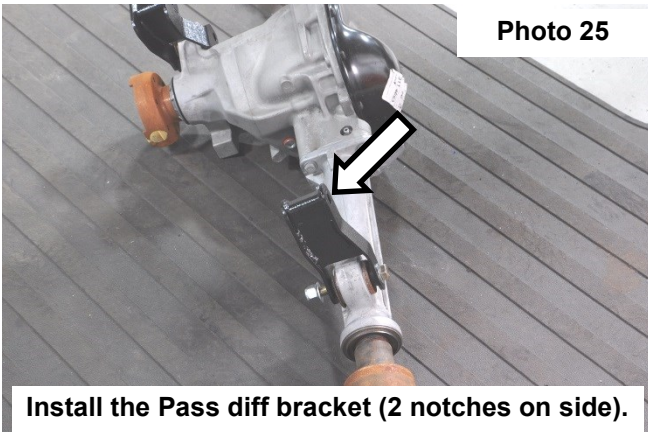

32. Install the rear diff mount using the supplied 9/16" x 4" hardware. Do not tighten at this time. **See Photo 27.**
33. Raise the differential into place and install the upper differential bolts using the stock hardware. **See Photo 28.** Do not tighten at this time.

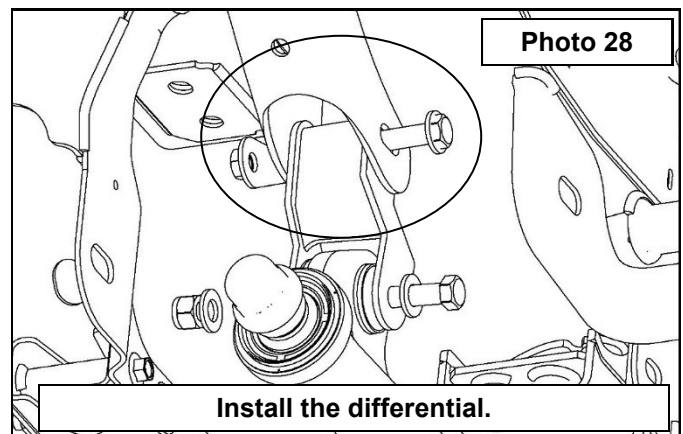
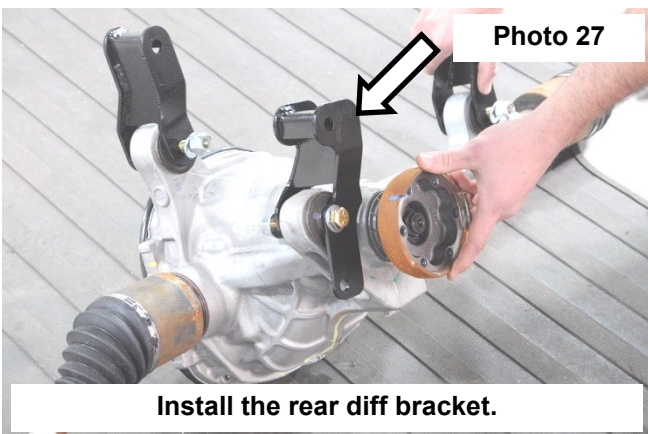

34. Install the sway bar drop brackets using factory hardware. **Do not tighten at this time.**
35. Install the rear cross-member with the supplied 18mm x150mm bolt. The bolt will install through the sway bar bracket and rear cross-member, securing it to the stock location. Do not tighten at this time. Install the RC decal on the swaybar brackets with supplied #8-32 bolts, and nuts using a 3/32" Allen wrench and 11/32" socket. **See Photo 29.**
36. Install the passenger side differential brace as shown in **Photo 30** using the supplied 12mm hardware in 1557BAG15. Do not tighten at this time.

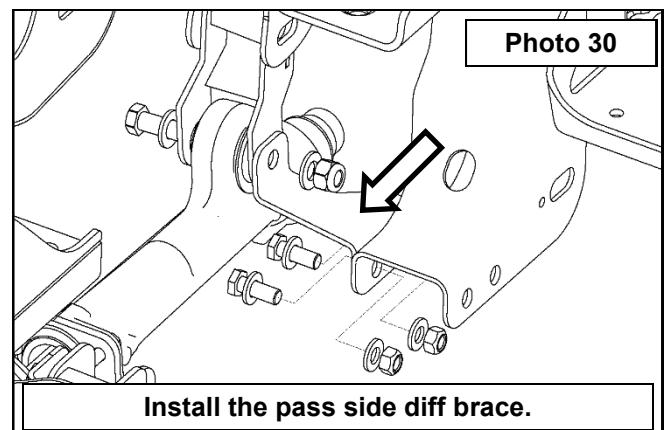
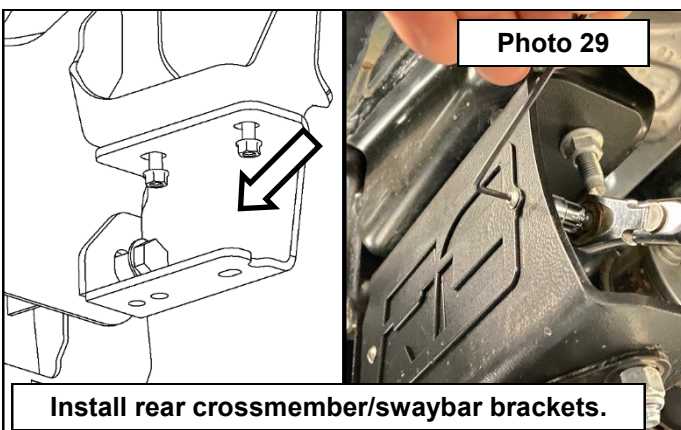



37. Install the rear drivers side diff mount. Use the factory bolt in the top mount and the supplied 1/2" hardware in the crossmember mount. Torque the factory bolt to 90ft-lbs and the 1/2" hardware to 90ft-lbs. **See Photo 31.**
38. Tighten the (3) 9/16" x4" differential bolts. Torque to 100ft/lbs with a 21mm socket and 22mm wrench. **See Photo 32.**
39. At this time tighten the (3) upper factory diff bolts. Torque to 90ft-lbs. using 18mm socket and wrench. Torque the lower 9/16" x4 hardware to 100ft/lbs using a 21mm & 22mm socket and wrench. Also torque the passenger side diff brace hardware to 55ft/lbs using a 19mm socket & 18mm wrench.

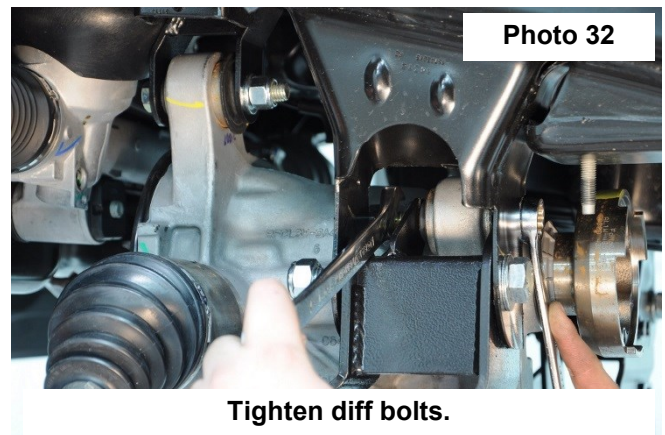
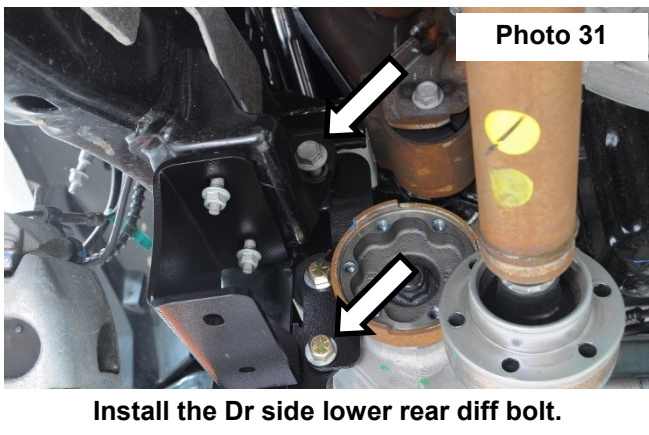

40. Tighten the sway bar drop mounts to the frame. Torque nuts to 35ft-lbs. using a 15mm socket. **See Photo 33.**
41. Reinstall the vent tube on the differential with the new supplied vent tube extension 1557BAG13.
42. Install the front cross-member using the factory hardware. **See Photo 34.** Do not tighten at this time.

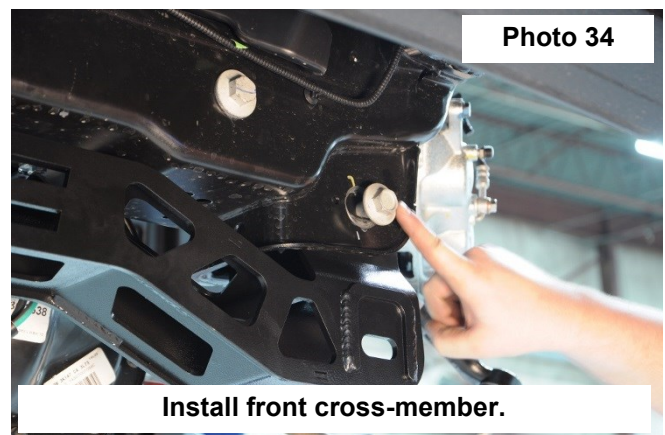
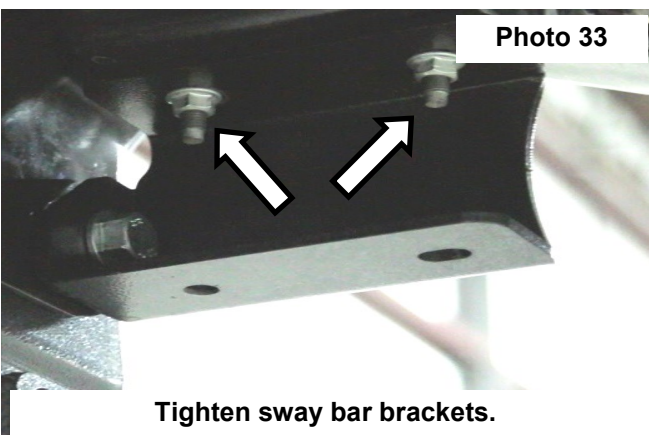

43. Install the lower control arms using the supplied 18mm x 160mm cam bolts, washers and nuts using a 1 1/16" socket/wrench. **See Photo 35.** Do not tighten at this time.
44. Install the new skid plate in the rear cross member threaded holes using the supplied 3/8" x 1" bolts, washers. Attach to the front cross member using the supplied 3/8" x 1" bolts, washers and nylock nuts. **See Photo 36.** Torque using a 9/16" socket and wrench to 30ft-lbs.

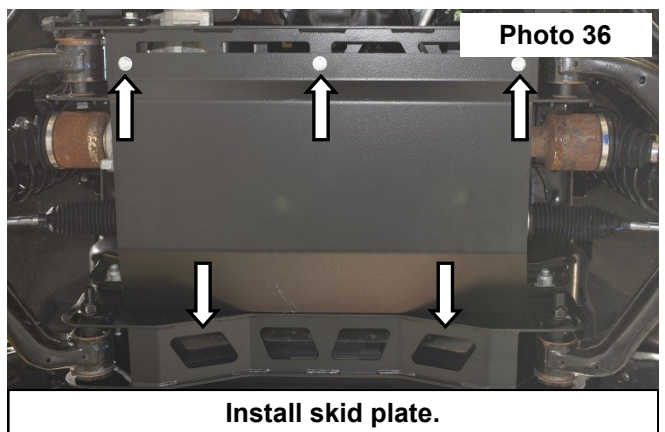
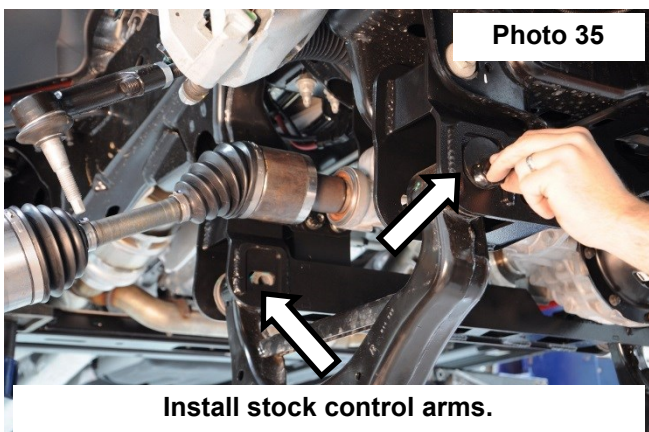

45. Tighten all upper cross-member bolts. Torque to 190 ft-lbs using a 21mm, 1 1/16" socket and 1 1/16" wrench.





46. Install the drive shaft using stock hardware. **See Photo 37.** Torque to 35ft-lbs.

47. Using a 10mm wrench remove the brake line bracket from the driver and pass side frame. **See Photo 38.**

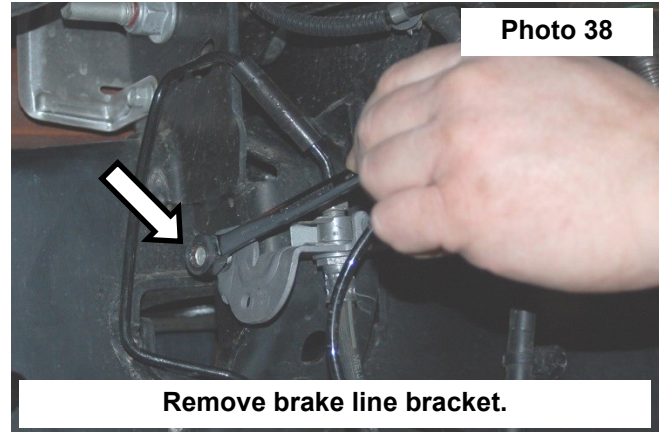
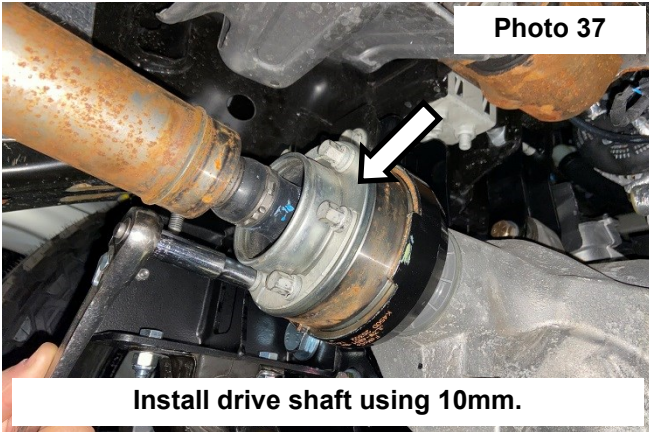

48. On the passenger side remove the brake line from the two factory clips. **See Photo 39.**

49. Install the new brake line bracket on the driver and passenger side with the stock hardware. **See Photo 40.**

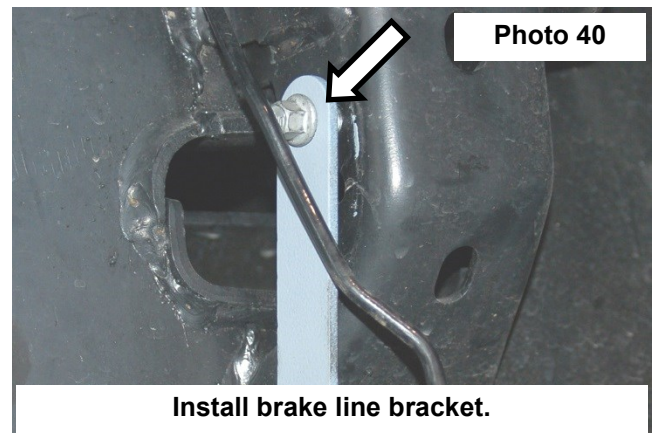
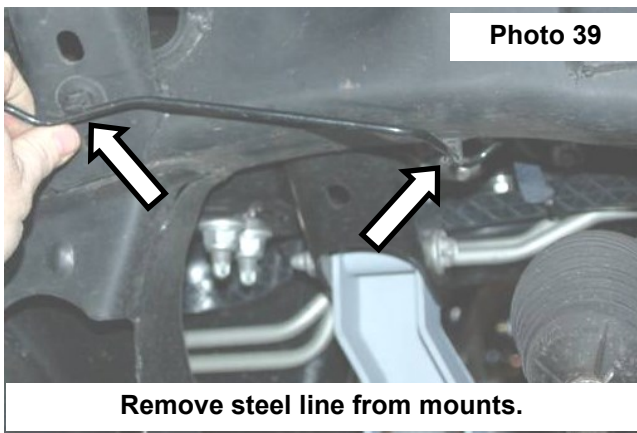

50. Install the factory passenger side brake line in the new bracket using the supplied 5/16" x 3/4" bolt, washer and nuts. **Take care to not kink the brake line. See Photo 41.**

51. On the driver side, pull slightly on the brake line to allow the line to be installed on the new bracket. Secure the brake line to the new bracket with the supplied 5/16" x 3/4" bolt, washers and nut. **Take care to not kink the brake line.**

52. Using a 13mm socket / wrench, torque the supplied brake line bolts to 15ft-lbs. Torque stock hardware to 18ft-lbs.

**▲ NOTICE** If installing new lifted struts or Vertex coil overs, follow supplied strut instructions and skip to step 56.

52. Install the supplied 10mm studs in the strut spacers with a 17mm wrench, using the 1/2" jam nut. **See Photo 42.**

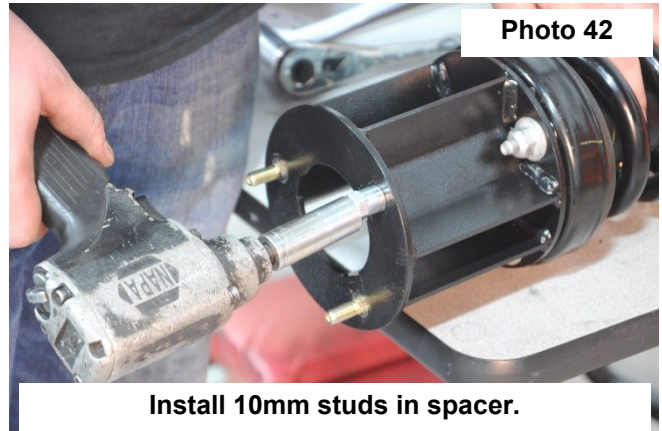
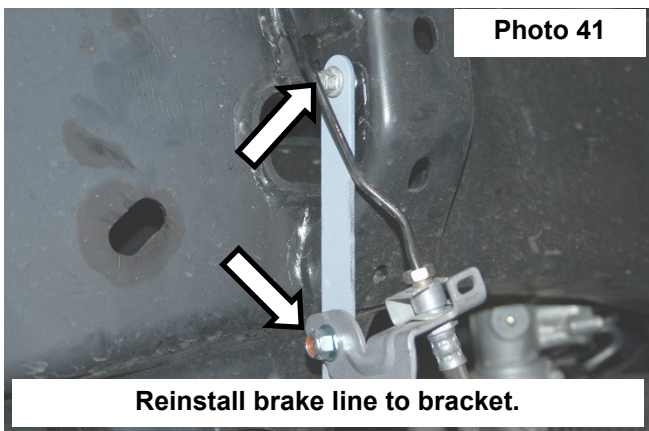



54. Using the stock hardware, install the strut spacers on the struts. Torque to 45ft-lbs. using a 15mm. **See Photo 43.**  
 55. Install the strut with strut spacers installed in the stock upper mount. Secure with supplied 10mm nuts, washers and lock washers. **See Photo 44.** Do not tighten at this time.

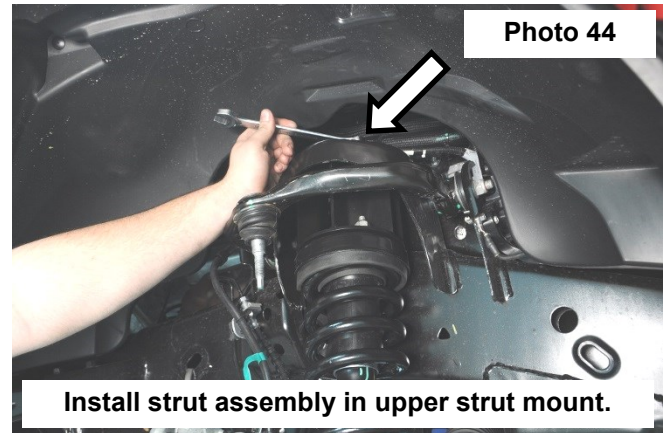
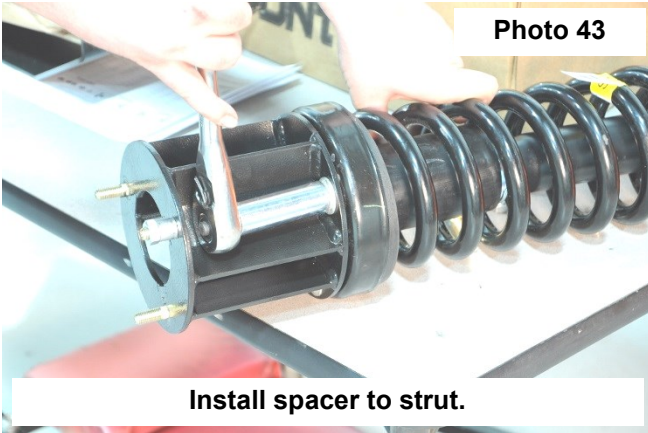

56. Install the lower strut in the lower control arm using the factory hardware. Torque using a 18mm socket.  
 57. Torque upper strut mount hardware using 17mm wrench.  
 58. Reconnect the sway bar links to the knuckles using a 21mm wrench and T45 Torx bit. Install nut to hold the sway bar in place but do not tighten at this time. **See Photo 45.**  
 59. Swing up the sway bar and install on the sway bar drop brackets using the supplied 7/16" x 1" bolts, washers and nuts. Torque to 45ft-lbs. using a 5/8 wrench and socket. Torque the sway bar links to 18ft-lbs. using an 18mm socket. **See Photo 46.**

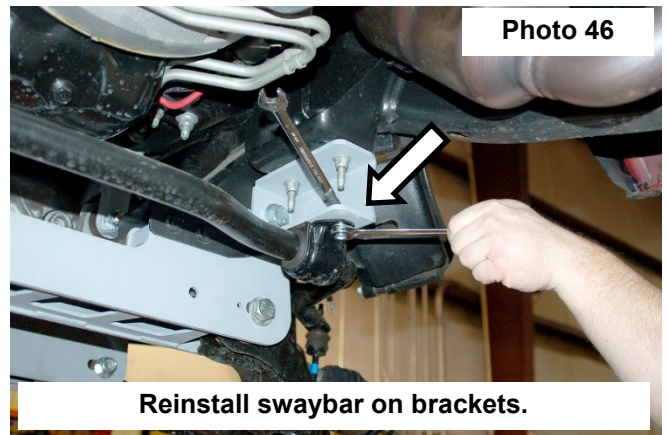
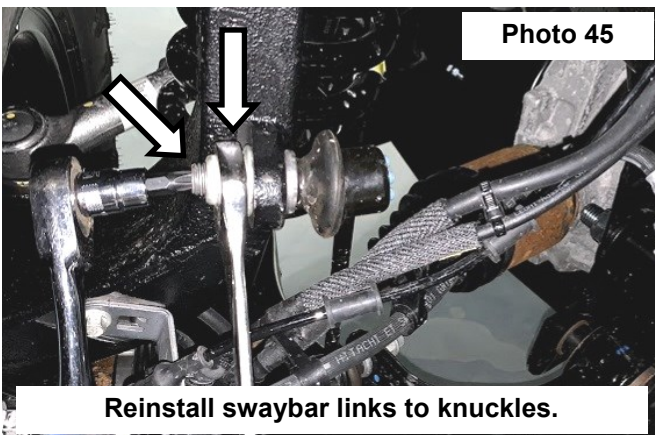

60. Install the RC knuckles to lower control arm first using a 24mm socket/wrench and then install actuator to knuckle using an 8mm socket/wrench. After sliding actuator onto axle, install the knuckle to upper control arm. **See Photo 47.**

**NOTE: Do not use an impact drill on the upper and lower ball joint, tighten with hand tools.**

61. Install the tie rod end using a 21mm socket wrench and install the rotor. **See Photo 48.**

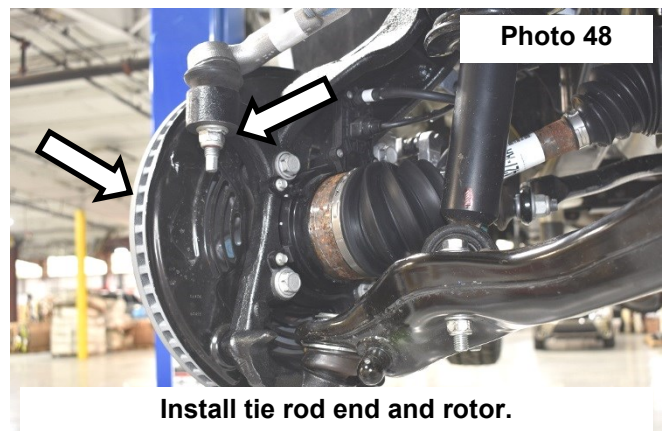
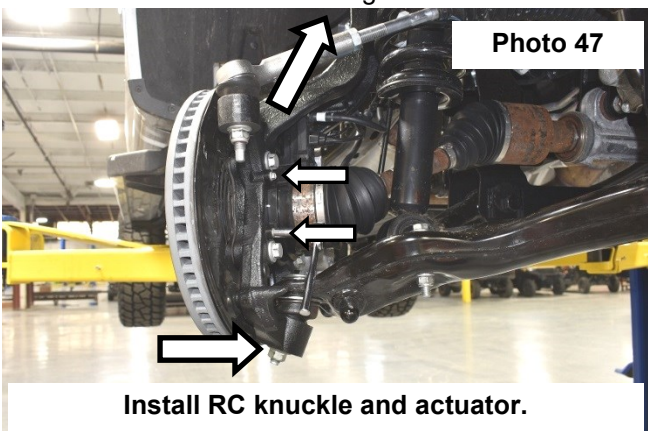



62. Install axle nut and torque to 30ft-lbs. **▲ NOTICE** Do Not Use an impact, caution must be taken or damage to shaft may occur. **See Photo 53.**
63. Install the ABS wire on the bearing assembly, torque to 8 ft-lbs. using a 5mm Allen. **See Photo 54. Install the factory dust shield on the supplied knuckle, using factory hardware. torque to 14ft-lbs. use a 8mm socket.**

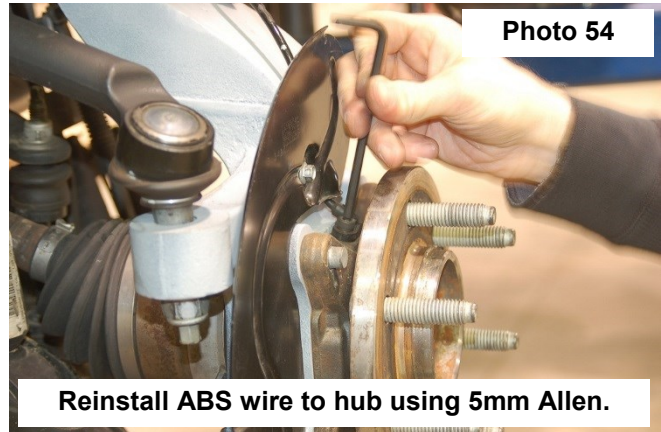

64. Install the caliper to the knuckle with the stock hardware, Torque to 140ft-lbs. using a 21mm socket. **See Photo 55.**

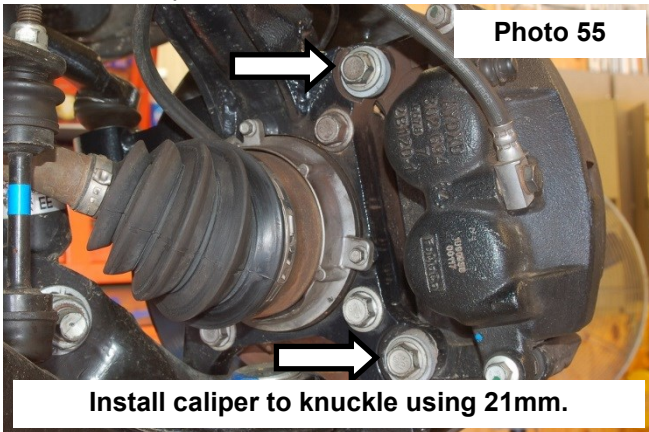

65. Make sure the ABS wire are out of harms way. Using a zip tie, secure the and ABS wire to the knuckle neck.
66. Install the tires and wheels using a 21mm socket. Remove the jack stands and lower the truck to the ground.
67. Tighten the lower control arm bolts using a 1-1/16" wrench and socket. **Torque to 240 ft/lbs.**

## REAR INSTALLATION INSTRUCTIONS

1. Chock the front tires and jack the rear the rear end up. Put jack stand under the frame rail and lower truck onto jack stands.
2. Remove tires and wheels using a 21mm socket.
3. Remove rear shocks from the upper and lower mount using 18mm and a 15mm wrench. **See Photo 1 & 2.** Retain the stock hardware.

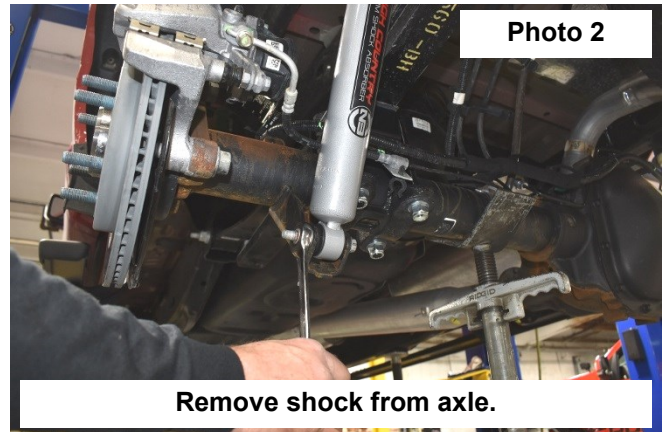
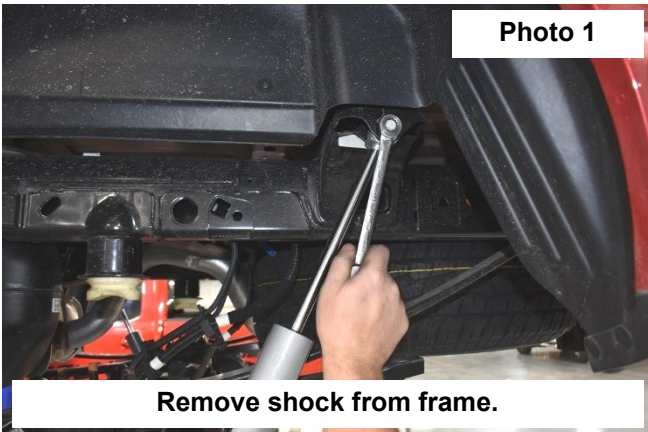

4. Using a 10mm wrench, remove the brake line assembly on the inner driver side frame rail. **See Photo 3.**
5. Install the brake line assembly to the new bracket using the supplied 3/8" x 1" bolt, washers and nut. Torque to 30ft-lbs. using a 9/16" socket and wrench. **See Photo 4.**
6. Install the brake line extension bracket on the frame using the stock hardware and torque to 18ft-lbs. using a 10mm socket. **See Photo 4.**

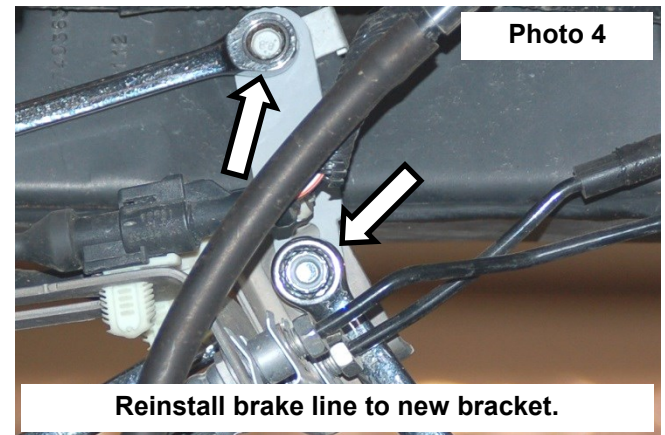
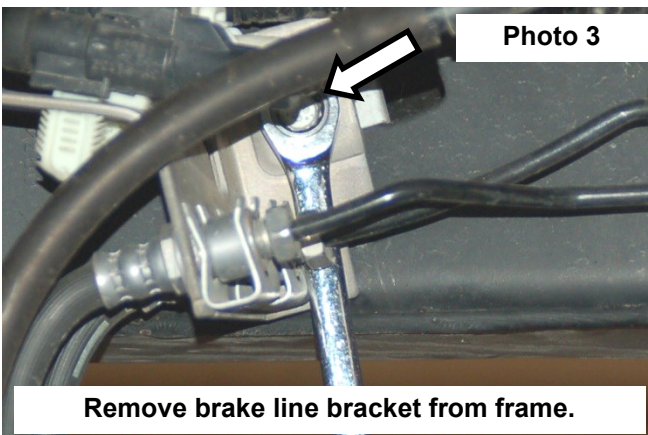

9. Using a jack support the rear end and remove U-bolts using a 21mm socket and remove the factory blocks. **Retain factory block for the 4" kit. See Photo 5.**
10. Install the supplied blocks on the block pin holes on the axle and raise the axle into place. **See Photo 6.**  
**NOTE:** The 4" kit will have a standard block with the factory block while the 6" kit will use the Rough Country Anti-wrap design blocks.  
**NOTE: Taller end of block to the rear of the truck!**

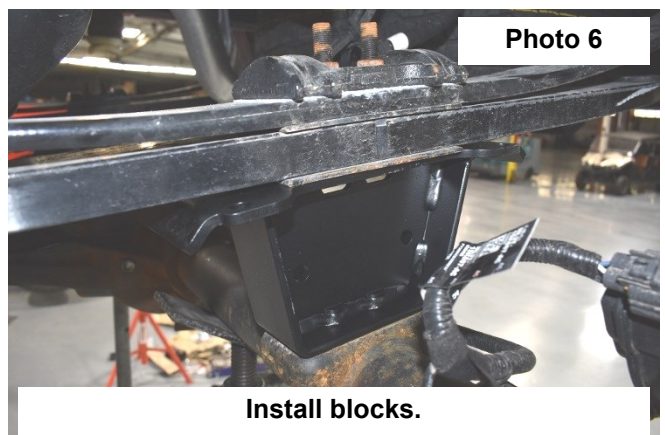
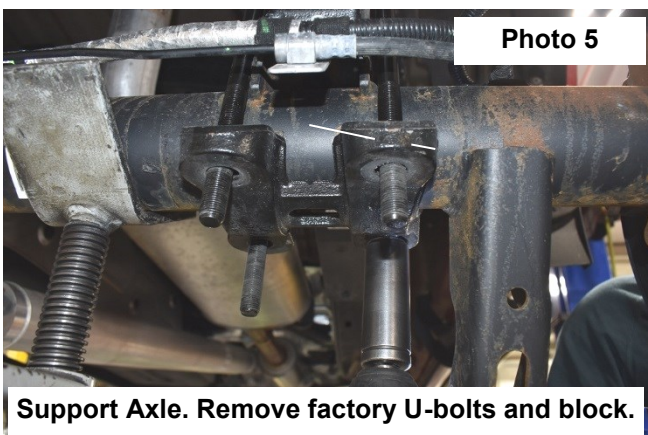



11. Install the axle u-bolts, torque to 90ft-lbs. using a 22mm socket.
12. **NOTE: 6" Kit Only.** Install Anti-wrap u-bolts over the leaf spring and into the blocks. Install the supplied shims between the leaves. Secure with supplied hardware and torque to 45ft-lbs using a 16mm socket. **See Photo 7.**
13. **NOTE: 6" Kit Only.** Install the supplied rear bump stop bracket, with the supplied 3/8" x 3.5" round u-bolt, and 3/8" nylock nuts, making sure the bracket lines up with the factory bump stop. Torque to 30ft-lbs. with a 9/16" socket. **See Photo 8.**

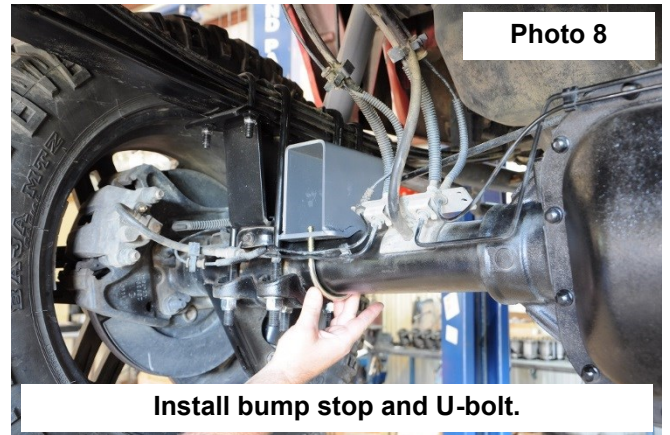
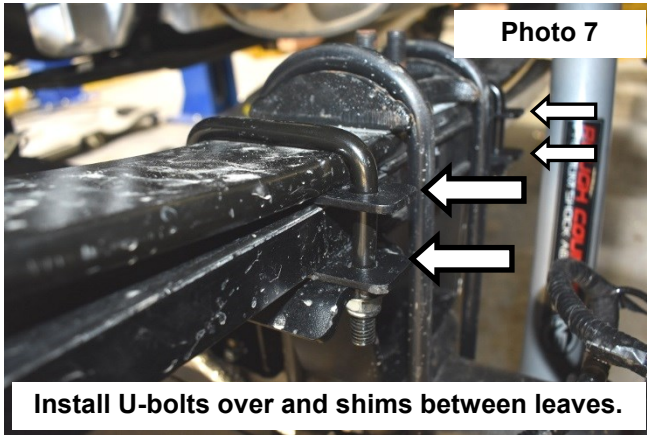

15. For V2 rear shocks and Vertex rear shocks follow shock installation instructions included in shock package and skip to step 17.
16. Install the new shock absorbers in the upper and lower mounts using the stock hardware. Torque to 55ft-lbs. using a 18 and 15mm wrench. **N3 shocks will mount with the body down.**
17. Install the rear tire and wheels.
18. Raise up the rear of the vehicle and remove the jack stands. Lower the vehicle to the ground.





CUTTING / DRILLING TEMPLATE—FR SIDE OF DRIVER CROSSMEMBER

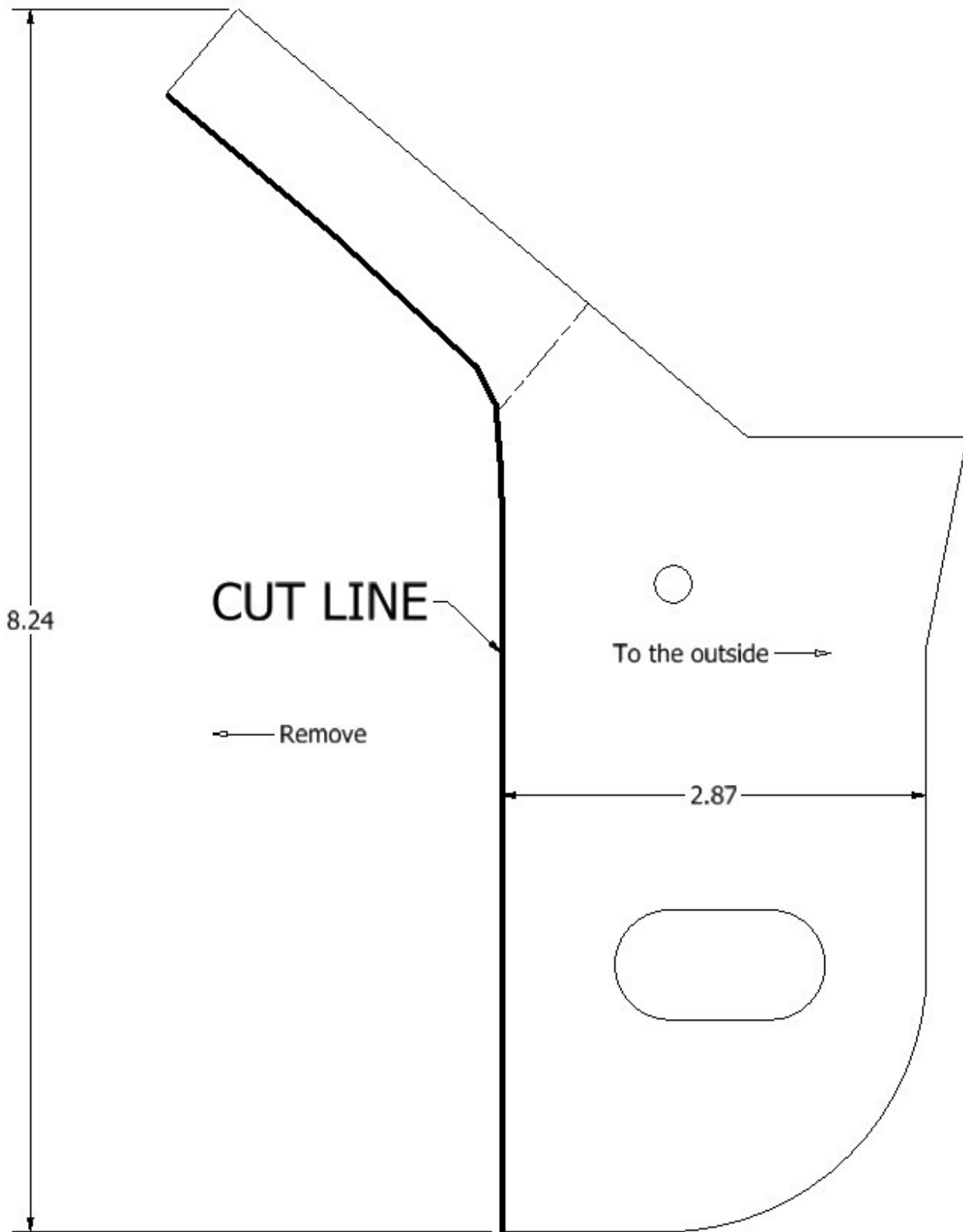



CUTTING / DRILLING TEMPLATE—REAR OF DRIVER SIDE CROSSMEMBER

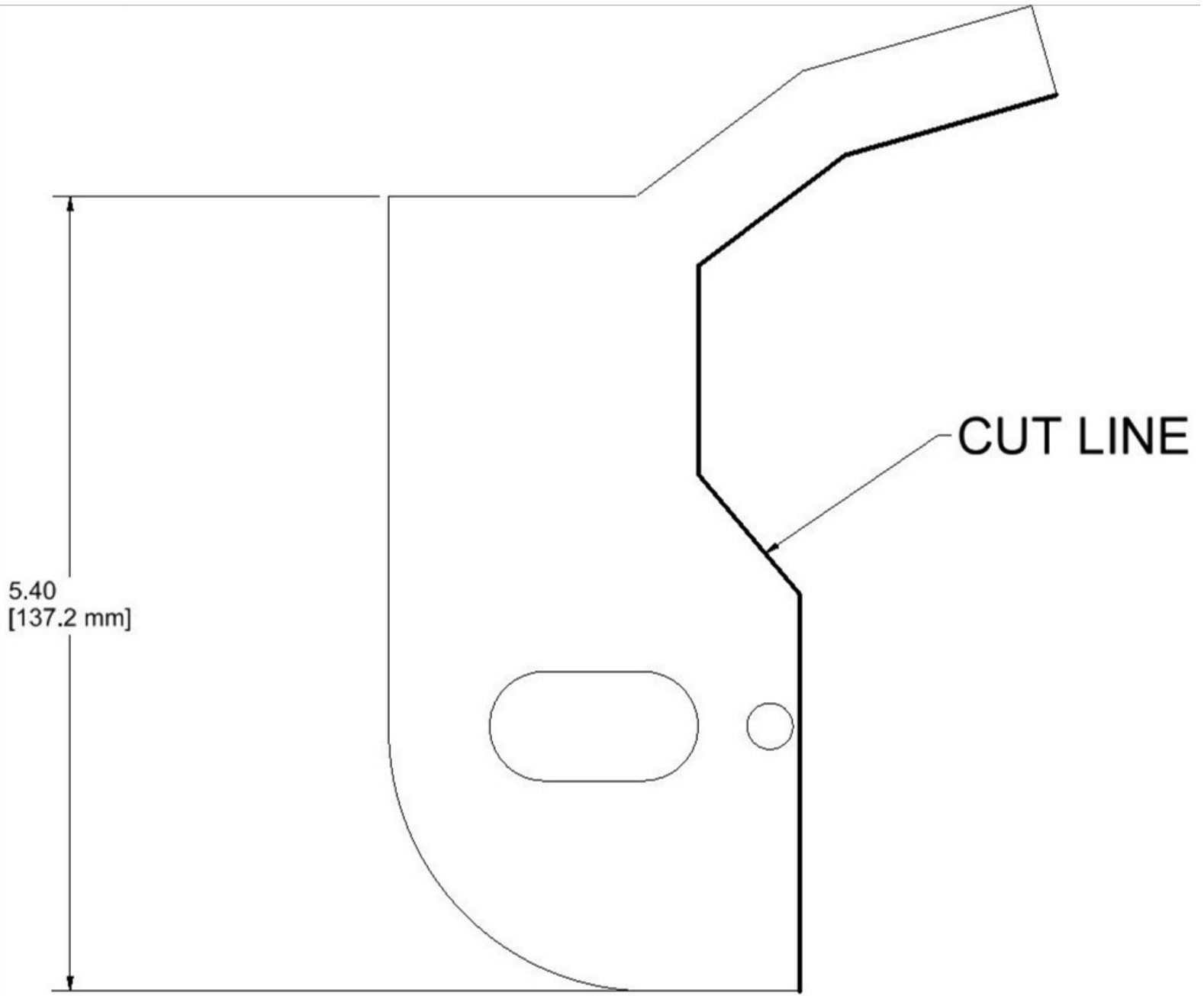





## POST INSTALLATION INSTRUCTIONS

1. Check all fasteners for proper torque. Check to ensure there is adequate clearance between all rotating, mobile, fixed and heated members. Check steering gear for interference and proper working order. Test brake system
2. Perform steering sweep. Check to ensure brake hoses have sufficient slack and will not contact rotating, mobile, or fixed members, adjust lines/brackets to eliminate interference and maintain proper working order. Failure to perform inspections may result in component failure
3. Readjust headlights to factory settings
4. Have vehicle aligned by a certified alignment professional.
5. Re-torque all nuts, bolts, and especially u-bolts after the first 100 miles, again after another 100 miles and then check periodically thereafter
6. All components must be retightened after 500 miles, and every three thousand miles after installation.

### **Thank you for purchasing a Rough Country Suspension System.**

By purchasing any item sold by Rough Country, LLC, the buyer expressly warrants that he/she is in compliance with all applicable , State, and Local laws and regulations regarding the purchase, ownership, and use of the item. It shall be the buyers responsibility to comply with all Federal, State and Local laws governing the sales of any items listed, illustrated or sold. The buyer expressly agrees to indemnify and hold harmless Rough Country, LLC for all claims resulting directly or indirectly from the purchase, ownership, or use of the items.





