

# 2019-20XX JEEP GLADIATOR

## BODY MOUNT ROCK RAIL INSTALLATION INSTRUCTIONS



## SAFETY

**Know safety, no injury. Know injury, no safety. ~Author Unknown**

If there are any questions, call 1-855-HHTOUGH

- **READ ALL SAFETY INSTRUCTIONS BEFORE INSTALLATION**
  - FOLLOW ALL INSTRUCTIONS FOR PROPER ASSEMBLY
  - WEAR APPROPRIATE EYE PROTECTION
  - EXERCISE CARE WHEN LIFTING COMPONENTS
  - USE APPROPRIATE TORQUE FOR BOLTS
  - BLUE THREAD LOCKING COMPOUND IS RECOMMENDED ON ALL BOLTS

California Proposition 65



**WARNING**

Cancer and Reproductive Harm

[www.P65Warnings.ca.gov](http://www.P65Warnings.ca.gov)

DO NOT PAINT OVER THIS LABEL. REPLACE IF DAMAGED OR LOST

DKB150\_00



## 2018-20XX JEEP JL

600-56-0937

<b>Suggested Torque Values For Steel Grade 5 Standard Bolts</b>		
BOLT DIAMETER (INCH)	THREADS PER INCH	TORQUE (POUND - FEET)
1/4	20	7
5/16	18	14
3/8	16	25
7/16	14	40
1/2	13	60
9/16	12	88
5/8	11	120
3/4	10	200
7/8	9	302
1	8	466

<b>Suggested Torque Values For Steel Grade 8.8 Metric Bolts</b>		
BOLT DIAMETER (mm)	THREAD PITCH (mm)	TORQUE (POUND- FEET)
6	1.0	7
8	1.25	16
10	1.5	32
12	1.75	55
14	2.0	88
16	2.0	140
18	2.5	195
20	2.5	275
22	2.5	375
24	3.0	475



2018-20XX JEEP JL

600-56-0937

## I. PARTS LIST

ITEM NO.	QTY.	PART NUMBER	DESCRIPTION
1	1	601-56-3744	3048MM LENGTH FOAM ROLL
2	2	601-56-3942	FRONT STEP PLATE
3	2	601-56-3943	REAR STEP PLATE
4	4	601-56-5113	ROCK LIGHT BRACKET
5	1	60K-56-0162	HARDWARE KIT #162
6	1	60P-56-0937	LEFT ROCK RAIL
7	1	60P-56-0938	RIGHT ROCK RAIL

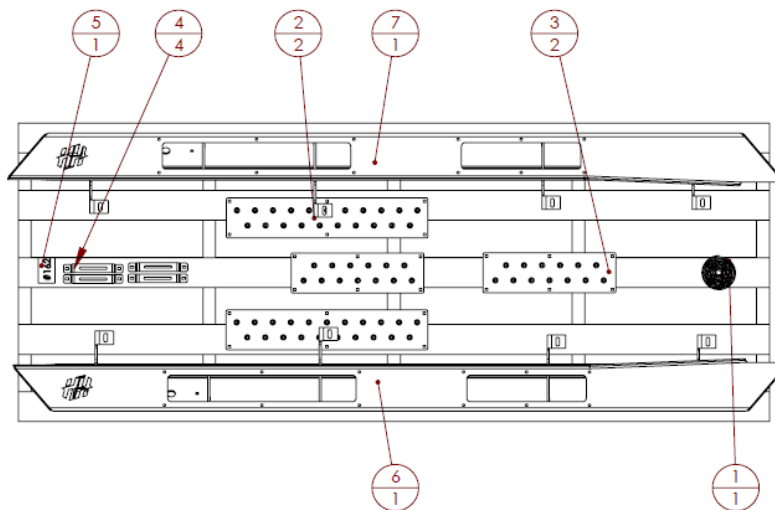

**REMOVE CONTENTS FROM BOX AND VERIFY ALL PARTS ARE PRESENT.**

**If there are any questions, call 1-855-HHTOUGH or email**

**HHORDERS@hammerheadarmor.com**

## II. TOOL LIST

1. A good friend
2. Basic tool kit
3. 10mm socket
4. Torx 40
5. Torx 20
6. 13mm wrench
7. 7/16 socket
8. 7/16 wrench



2018-20XX JEEP JL

600-56-0937

### III. VEHICLE PREPARATION

1. Remove any already installed rock rails or running boards
2. Remove the 2 bolts holding the front fender to the pinch seam using the 10mm socket

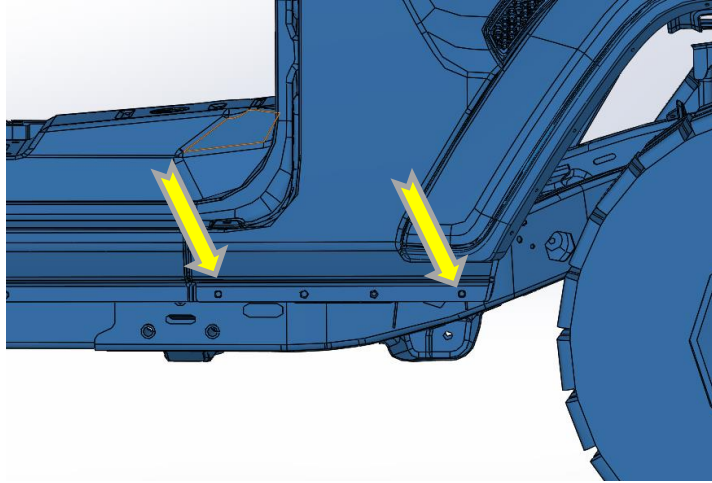

### IV. PREPPING THE ROCK RAIL FOR INSTALL

1. Install the provided foam as shown.

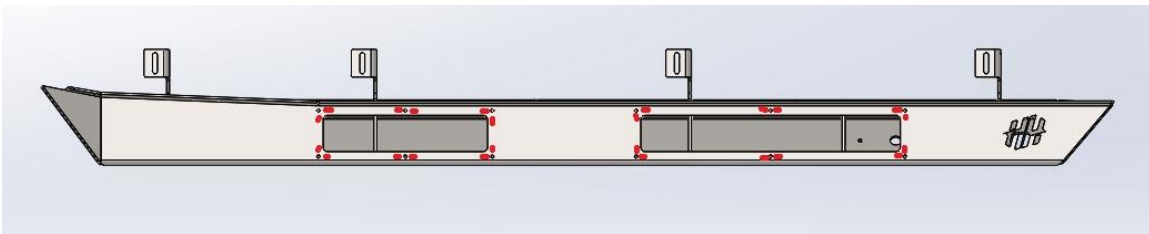

2. Using the twelve 1/4" carriage bolts, washers and nuts install the step plates as shown. You will use the 7/16" wrench or socket for this step. Make sure the step perforations are sticking up for grip.

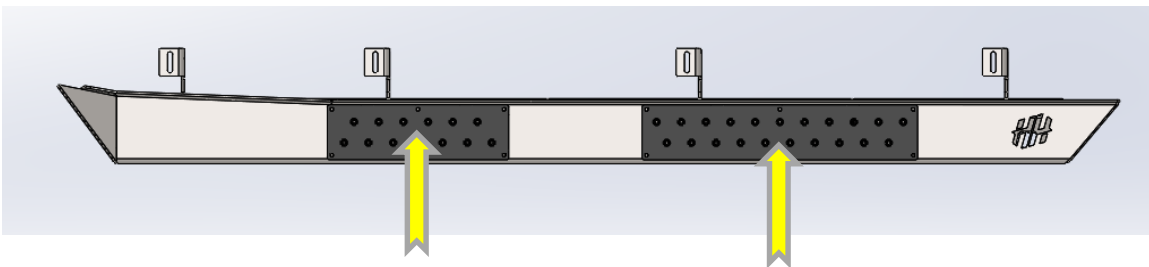



## 2018-20XX JEEP JL

600-56-0937

- Using the eight 1/4" carriage head bolts, washers, and nuts install the 2 rock light brackets. You will use the 7/16" socket. If you have rock lights, install them on the rock light bracket.
- Bolt the rock rail to the pinch seam using 8 of the provided torx 40, 8mm bolts, washers, and nylock nuts. Use the Torx 40 and the 13mm wrench. Do not tighten yet. (HH goes toward the front of the Jeep)

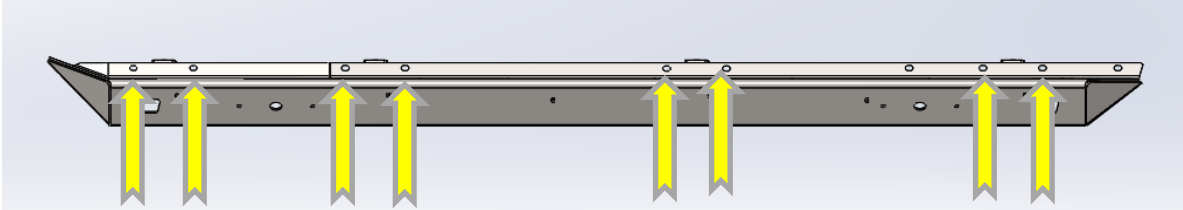

- Install two torx 20, 6mm bolts and black washers where you removed the two factory fender bolts.

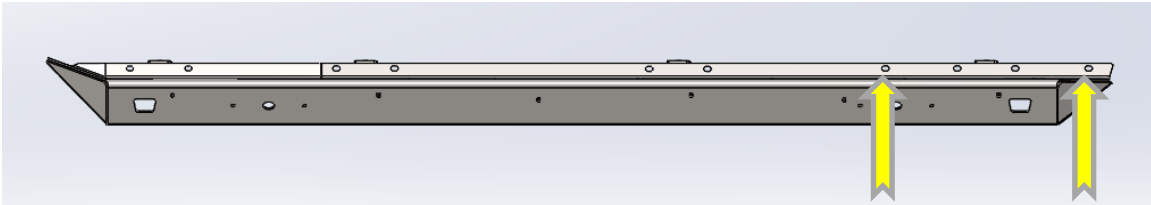

- Install four Torx 40, 8mm bolts and washers into the underside of the body.

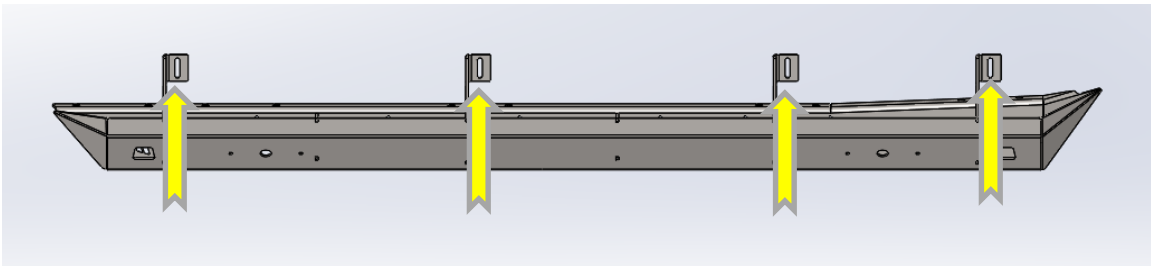

- Repeat this process for the other side. Tighten all bolts to spec.



## 2018-20XX JEEP JL

600-56-0937



**Congratulations! Your Installation is now complete.  
Thank You for your purchase!**